

OPERATING AND INSTALLATION INSTRUCTIONS

**High-Pressure
Diaphragm Pumps
made of Plastic**



AHD Series

AHD 15

AHD 25

AHD 40



Original Instruction
Read carefully before pump installation

CONTENTS

	Page
1. Introduction	3
1.1. General description of the machine, appropriate use and residual dangers	3
1.2. Storage	3
1.3. Codesystem	3
2. Technical data	5
2.1. Performance charts	5
2.2. Dimensions	7
3. Installing the pump	8
3.1. Installation into the piping system	8
3.1.1. Product ports	8
3.1.2. Connecting the air supply	8
3.2. Start-up and operation of the pump	9
3.3. Further safety hints	10
3.4. Additional temperature hints	11
3.5. Providing spare parts	12
4. Disassembly of the elements of construction	12
4.1. Pump housings and manifolds	12
4.2. Suction and discharge valves	13
4.3. Diaphragms	13
4.4. Dual stage housing	14
4.5. Center block	14
4.5.1. Shaft piston rings	14
4.5.2. Air control system <i>PERSWING P®</i>	14
4.5.3. Air filter	14
5. Assembly of the elements of construction	15
5.1. Center block	15
5.1.1. Air control system <i>PERSWING P®</i>	15
5.1.2. Shaft piston rings	15
5.2. Dual stage housing	15
5.3. Diaphragms	15
5.4. Suction and discharge valves	16
5.5. Housing bolts with spring washers	16
5.6. Pump housings and manifolds	16
6. Testing advises	17
6.1. Air valve	17
6.2. Correct function and sealing	17
7. Troubleshooting	18
8. Spare part list	20
9. Exploded view	21
10. Optional equipment	22
10.1. Stroke counting	22
10.2. Diaphragm monitoring	23
10.3. ANSI flange connections	23
10.4. Spare part list optional equipment	23

1. INTRODUCTION

ALMATEC high-pressure diaphragm pumps are constructed according to the state of the art and they are reliable. Imminent danger by operating error or misuse can lead to damages of properties and/or persons. The pumps are to be applied for the intended use and in a safety-related proper condition only.

Each person working on the ALMATEC high-pressure diaphragm pumps concerning installation, start-up, handling or maintenance has to read this manual completely and in an attentive way and has to follow all mentioned procedures and safety notes.

1.1. General description of the machine, appropriate use and residual dangers

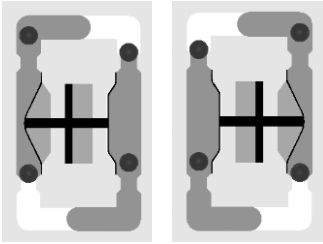

The ALMATEC AHD Series pumps are oscillating positive displacement pumps and are based on the functional principle of double diaphragm pumps. The basic configuration consists of two external side housings with a center block between them. Each of the side housings contains a product chamber which is separated from the center block by a diaphragm. The two diaphragms are interconnected by a piston rod. Controlled by an air control system, they are alternately subjected to compressed air so that they move back and forth. The pressure booster centered between the diaphragms boosts the drive air pressure to more than twice its original value in the two product chambers. In the first diagram, the compressed air has forced the left-hand diaphragm towards the product chamber and displaced the liquid from that chamber through the open valve at the top to the discharge port. Liquid is simultaneously drawn in by the right-hand diaphragm, thus refilling the second product chamber. When the end of the stroke is reached, it reverses automatically and the cycle is repeated in the opposite direction. In the second diagram, liquid is drawn in by the left-hand diaphragm and displaced by the right-hand diaphragm.

The appropriate use of an Almatec high-pressure diaphragm pump of the AHD series refers to the liquid (or sludge) transport taking into account the operation parameter mentioned in this manual and in compliance of the given terms for commissioning, operation, assembly, disassembly and maintenance.

Even if all necessary safety measures described in this manual have been met, a residual danger exists by leakages or mechanical damages. At sealing areas or connections liquid can be released uncontrollably then.

1.2. Storage

In general the ALMATEC pump is delivered operational and packaged. If the unit is not installed right away, proper storage conditions are important for a trouble free operation later. The pump has to be protected from wetness, coldness, dirtying, UV-radiation and mechanical influences. The following storage conditions are recommended:

- Steady ventilated, dust and vibration free storage room
- Ambient temperature between 15°C (59°F) and 25°C (77°F) with a relative humidity below 65%
- Prevention of direct thermal influences (sun, heating)

1.3. Code system

The ALMATEC Maschinenbau GmbH is certified as a modern, quality-orientated enterprise according to DIN EN ISO 9001:2008 and 14001:2004. Before release for dispatch, any pump of the AHD series has to undergo an extended final control. The performance data registered during this are archived in our records and can be read back at any time.

As a general rule in the countries of the EU only such machines are allowed to take into operation, which are

determined to meet the regulations of the EU machinery directive, the harmonized standards, European standards and the respective national standards. Hence the operator has to verify whether the ALMATEC pump manufactured and delivered properly according to the customer's order meets the mentioned requirements.

Therefore make sure, before putting the pump into operation, that the pump and the used materials of construction are suitable for the provided application and the installation site. To check this, the exact pump code is required. This code, the serial number and the year of construction are noted on the identification plates on the pump itself.

Based on the ALMATEC pneumatic diaphragm pump range, ALMATEC high pressure pumps AHD 15, AHD 25, AHD 40 have especially been developed for the requirements of feeding filter presses. Due to the integrated pressure transmission, they can achieve a discharge pressure of 15 bar (218 psig) with an air pressure of 7 bar (100 psig).

Here is an example to illustrate the system of the ALMATEC pump codes:

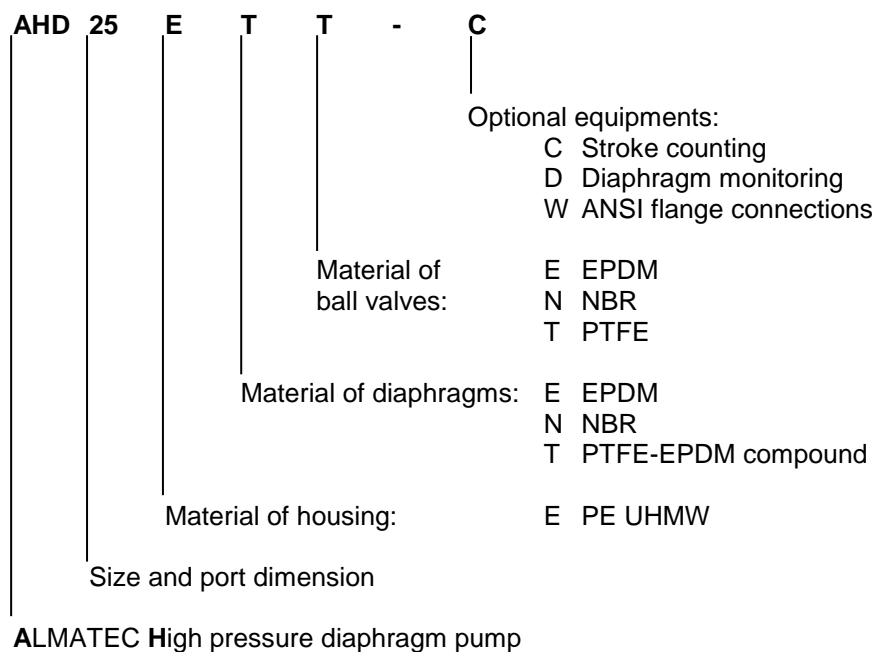

2. TECHNICAL DATA

Pump size		AHD 15	AHD 25	AHD 40
Dimensions mm ("):	width	312 (12.3)	422 (16.6)	539 (21.2)
	depth	177 (7.0)	256 (10.1)	291 (11.5)
	height	336 (13.2)	412 (16.2)	544 (21.4)
Flange connections, port DIN or ANSI		15 (1/2")	25 (1")	40 (1-1/2")
	Air connection BSP	1/4"	1/2"	1/2"
Weight kg (lbs)		11 (24)	24 (53)	53 (117)
Max. particle size of solids mm (")		4 (0.16)	5 (0.20)	8 (0.31)
Suction lift, dry mWC ('): EPDM/NBR ball valves		2 (6.6)	3.5 (11.5)	3.5 (11.5)
	PTFE ball valves	1,5 (4.9)	2 (6.6)	2 (6.6)
Suction lift, wet mWC (')		9.5 (31.2)	9.5 (31.2)	9.5 (31.2)
Max. driving and operating pressure bar (psig)		7 (100)	7 (100)	7 (100)
Max. operating temperature °C (°F)		70 (158)	70 (158)	70 (158)
Sound pressure level acc. to DIN 45635, part 24, depending on the operating data [dB (A)]:	driving pressure 3 bar	68-77	76-86	72-84
	driving pressure 5 bar	68-84	78-88	74-85
	driving pressure 7 bar	68-85	79-88	75-87

2.1. Performance charts

The data refer to water (20°C/68°F), under using of a compressor Atlas Copco VSG30 and calibrated measuring equipment. The specified performance data are warranted by ALMATEC in accordance with DIN EN ISO 9906. The blue lines state the air consumption in Nm³/min.

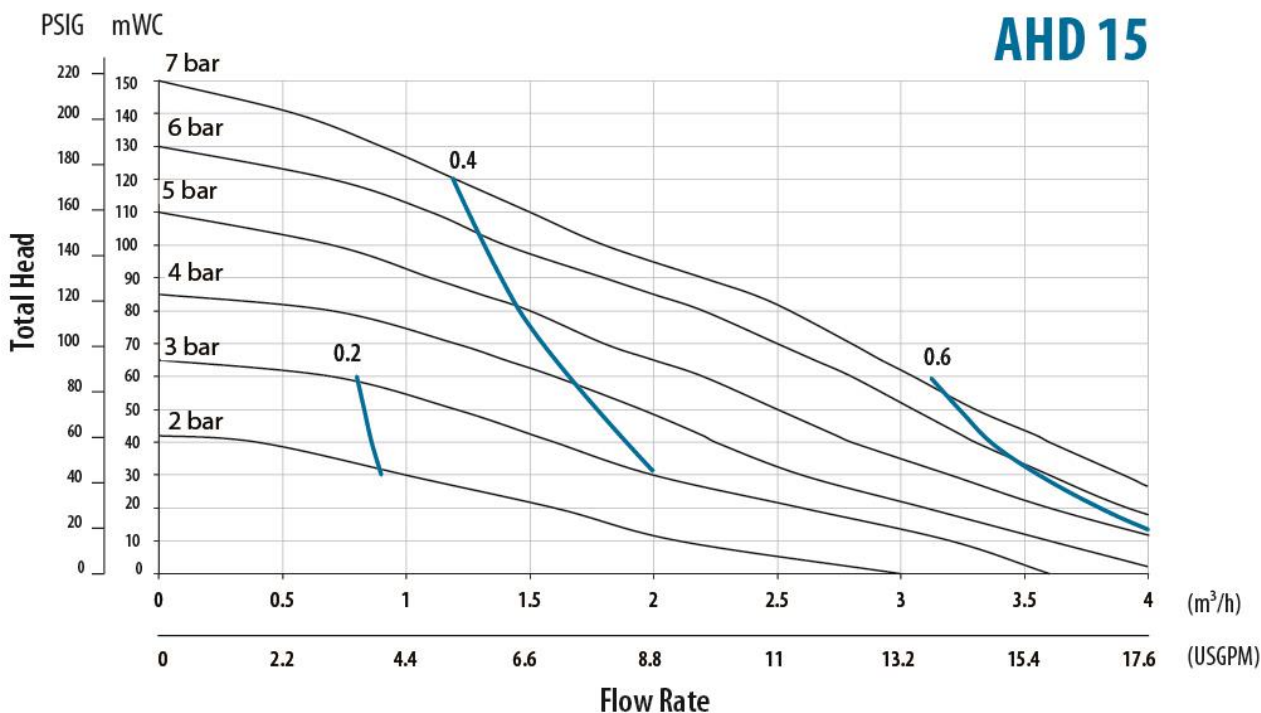

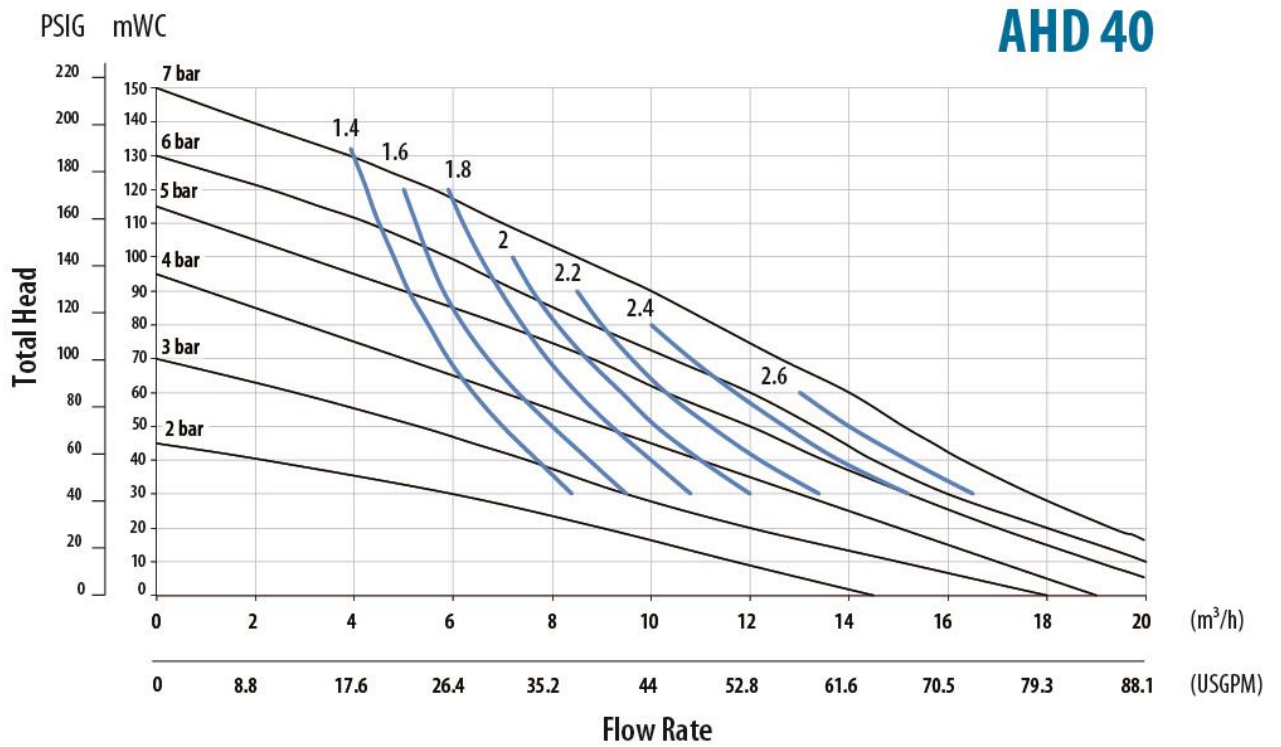
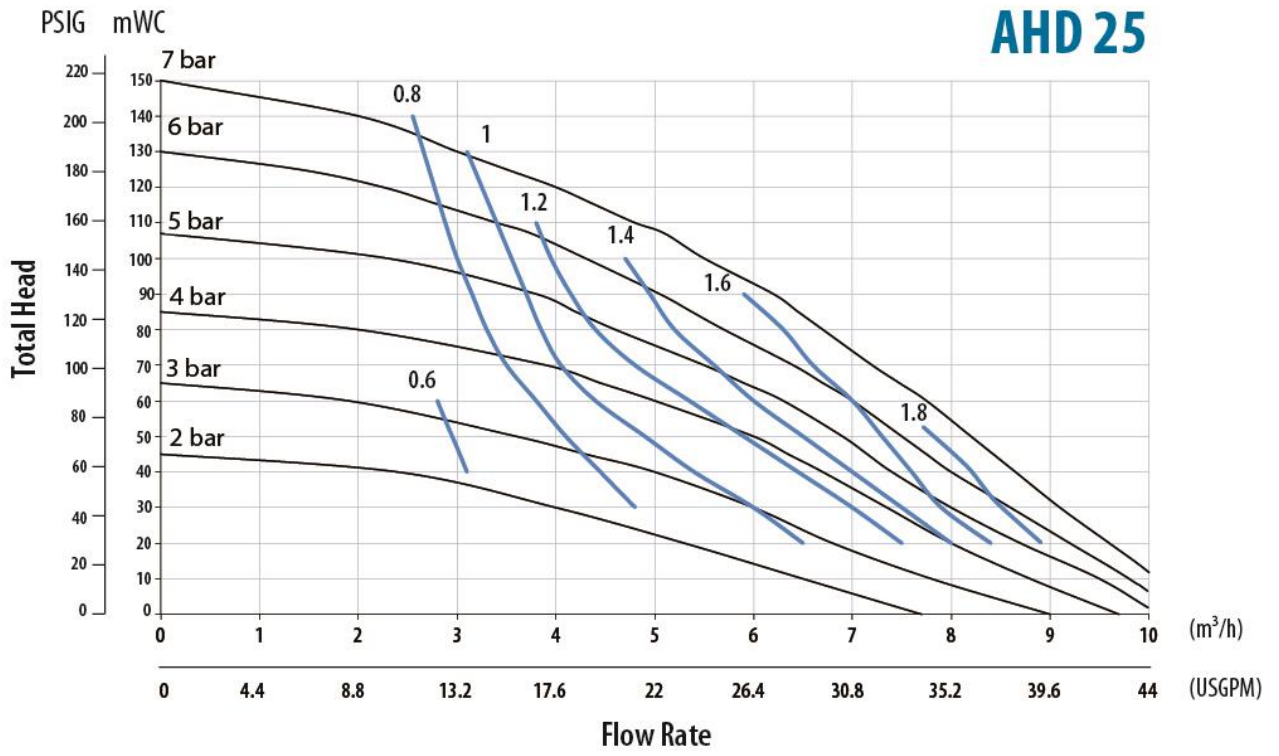

2.2. Dimensions

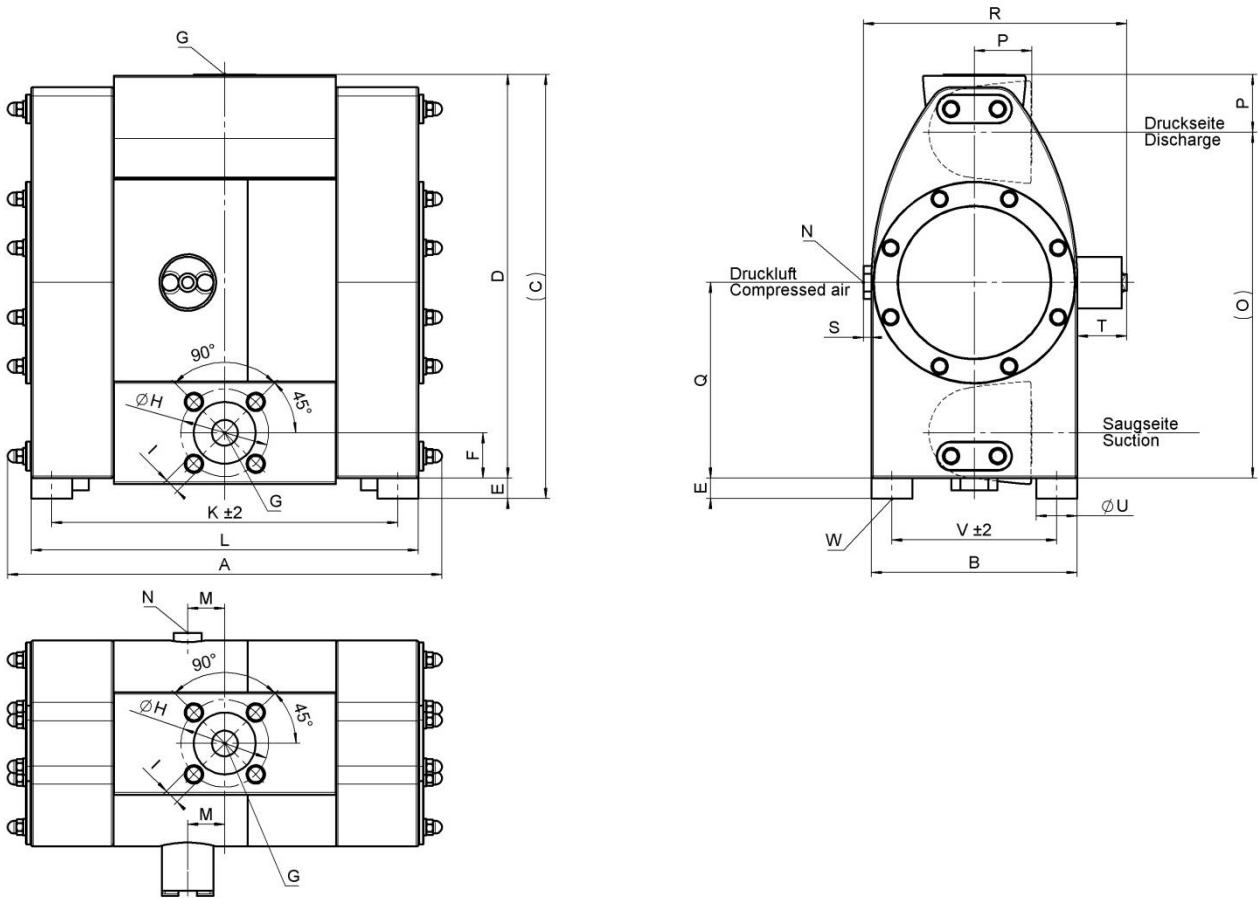

mm*	A	B	C	D	E	F	G	H	I	K	L	M	N	O	P	Q	R	S	T	U	V	W
AHD 15	312	152	336	316	20	37	DN15/PN16	65	M12	236	276	24	R 1/4"	263	53	150	177	5	20	40	112	M8
AHD 25	421	200	412	392	20	44	DN25/PN16	85	M12	336	376	36	R 1/2"	336	56	190	255	7	48	40	160	M8
AHD 40	539	270	544	524	20	60	DN40/PN16	110	M16	434	484	47	R 1/2"	454	70	257	291	7	14	50	220	M10
inch**	A	B	C	D	E	F	G	H	I	K	L	M	N	O	P	Q	R	S	T	U	V	W
AHD 15	12.3	6.0	13.2	12.4	0.8	1.5	ANSI 1/2" - 300lbs	2.6	1/2" UNC	9.3	10.9	0.9	BSP 1/4"	10.4	2.1	5.9	7.0	0.2	0.8	1.6	4.4	M8
AHD 25	16.6	7.9	16.2	15.4	0.8	1.7	ANSI 1" - 300lbs	3.5	5/8" UNC	13.2	14.8	1.4	BSP 1/2"	13.2	2.2	7.5	10.0	0.3	1.9	1.6	6.3	M8
AHD 40	21.2	10.6	21.4	20.6	0.8	2.4	ANSI 1-1/2" - 300lbs	4.5	3/4" UNC	17.1	19.1	1.9	BSP 1/2"	17.9	2.8	10.1	11.5	0.3	0.6	2.0	8.7	M10

* in mm, with DIN flanges

** in inch, with ANSI flanges

3. INSTALLING THE PUMP

The number in brackets, which is added to every part mentioned in the following explanations, refers to its position in the spare part list and the exploded view. UV-radiation can damage the housing parts of pumps made of PE. The operator is responsible for an adequately stability and an appropriate fixation of the piping according to the state of the art. To facilitate the installation and maintenance shut off valves should be installed right before and after the pump.

3.1. Installation into the piping system

Each of the shock absorbers [14] the pump is standing on is equipped with a female thread at its bottom for easy installation of the pump. Before connecting the pump, the blind plugs have to be removed from the suction and discharge manifolds [4] as well as the air inlet [21].

3.1.1. Product ports

In general, the pumps have to be connected load free. Neglecting this causes leakage and maybe even damages. They cannot serve as a fixing point within a piping system. To avoid vibrations compensators on both sides of the pump are recommended. Alternatively, hoses for suction and discharge help absorbing vibrations. These would as well avoid the transfer of pulsation and noise onto pipes, tanks and other parts of a plant, besides the conveyance is more gentle. These hoses have to carry an appropriate armourment to avoid diminishing the diameter of the suction pipe by the vacuum the pump develops.

The nominal width of the connection pipes has to be chosen in accordance to the connections of the pump. A smaller piping can cause cavitation (suction line) as well as a loss of performance (suction and discharge line). In case the pipe is too big, the dry suction capacity of the pump can decrease. Using flanges according to DIN DN 15/25/40 PN 16 or ANSI 300 lb/sq.inch, the suction line has to be connected to the lower manifold [4], the discharge to the upper one. The position of the manifolds can be varied in steps of 90° for a horizontal or vertical connection. To do so, the corresponding two housing bolts [13] have to be taken out beforehand. After turning the manifold [4], the bolts have to be fixed and tightened again.

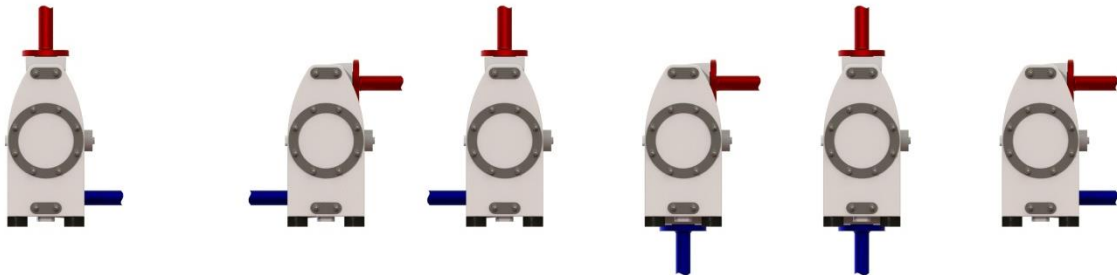

The first version is the standard configuration when the pump is shipped: Suction port horizontal and discharge port vertical to the top.

Seal the suction line diligently to avoid air intrusion. A suction line continuously rising will prevent the formation of air locks in the line which would affect the suction lift.

If pressurised air chambers are positioned beyond the pump discharge, these have to be disconnected from the pump by non-return valves. As the ALMATEC high pressure pumps regulates itself automatically according to the pressure of the filter press, additionally influencing the pump by a pressurised regulated air chamber cannot be permitted on principle.

3.1.2. Connecting the air supply

The air inlet [21] is located in the middle of the center block [19]. When delivered it is covered by a bilingual sticker with safety instructions, which can be easily removed. To supply the pump with driving air sufficiently, an appropriate diameter of the air supply line is required, at least the same nominal size as the air inlet of the pump (AHD 15: 1/4", AHD 25/40: 1/2"). We recommend connecting the pump via a hosepipe with adapter

and sealing. If this is not available, a direct connection via pipe thread and sparingly attaching some sealing tape is possible. Please note: The air inlet [18] is made of plastic to protect the center block [16], seal in carefully. Take care that no dirt or particles can intrude into the pump during the connection, as these can accumulate inside the pump and can cause malfunctions. An air filter [19] directly behind the air inlet [18] prevents the entry of bulk particles.

The following regulators should be included in the air supply line:

- Pressure regulator with maintenance unit/separator for condensed water (no oil supply)
The pressure regulator is used to adjust the final pressure the press will stop at. As a rough orientation a doubling pressure can be assumed, e. g. with 5 bar (72 psig) air supply, the pump will stop at a pressure of 10 bar (145 psig) inside the filter press. Please note: The time required for pressing increases along with the pressure. A higher pressure means a more dry filter cake and higher stress for all materials involved. A general guiding value cannot be given, the correct pressure has to be found out for every single application.
- Air throttle (e.g. needle valve)
This is helpful to limit the flow rate when starting to fill the press (without limiting the velocity, the pump will start very fast which results in a lower quality of the filter cake and increased wear of the pump). At the choice of the valve a sufficient pass-through capacity of the valve as well as an easy fine tuning has to be taken care of.

Besides, the following elements can be installed in the air supply line:

- Solenoid valve: depending on the automatisisation; optimally installed before the pressure regulator, as mostly regulated.
- Micro filter: protects the pump from remains of dirt and oil in the compressed air. A micro filter can replace an air maintenance unit.
- Pressure relief valve: prevents irregular regulation of the pump and filter press.

The integrated air control system PERSWING P® is a precision-control that requires oil-free, dry and clean compressed air for optimal function. The quality of the driving air for the pump depends on the operating conditions (e.g. flow rate at the beginning, final pressure of the filter press). For a rough orientation, we recommend to lean against the following quality classes of ISO-DIS-8573-1: solids - class 2, dew point - class 4-3, oil - class 3. Eventual icing of the muffler or the whole pump most often results from insufficiently dried driving air. A muffler [20] soiled after short period of operation indicates soiled driving air which can be helped by a micro filter chosen according to the max. air flow. In humid surroundings, icing from the outside may occur despite the driving air is dried. If so, a prolonged waste-air-exhaust (ca. 500 mm / 20 inch by pipe or hose) can be helpful. When installing the pump into boards or cabinets, it has to be ensured that cold air does not get caught behind the muffler. ALMATEC high pressure pumps do not require any lubrication. It has to be secured, that no oil can enter the pump. In applications with a tendency to freezing at the waste air exhaust, good experiences in practise have been achieved by pre-heating the driving air to increase the distance to the dew point of the air. Doing so, it has to be considered that the driving air temperature generally may not exceed 50°C (122°F) to avoid expansion and sticking effects on the air side. This max. air temperature is a well valid when using a compressor producing warm air which is e.g. often true for truck compressors.

3.2. Start-up and operation of the pump

When starting to install the pump, the housing bolts [13] have to be tightened. This has to be done before the pump develops a decent discharge pressure. The bolts [13] should be tightened crosswise and alternately starting with those arranged in the circle of the diaphragm. The aim of this is to work against the effect of housing parts "settling" after manufacture (e.g. during transport) because of varying temperatures.

The housing bolts [13] have to be fixed according to the torque data of the following schedule. At the beginning, the bolts need to be checked regularly and fixed if necessary. It can also be necessary after longer periods of stoppage, at extreme temperature variations, after transport and dismantling the pump. In case of temperature varying between extremes or high temperature difference between the liquid and the

surrounding, the housing bolts should be controlled more frequently (interval proposals are available on request). Once the pump is leaking because of insufficient tension of the bolts, it cannot be sealed completely by just tightening the bolts without cleaning the surfaces. The pump has to be opened and the sealing surfaces have to be cleaned carefully. Especially the round sealing groove in the pump housing [1] needs to be cleaned diligently.

Size	AHD 15	AHD 25	AHD 40
Torque values for housing bolts Nm (ft lbs):	8 (5.9)	13 (9.6)	24 (17.6)

The pressure of the driving air should be limited to the amount required to meet the performance needed. Excessive pressure increases both the air consumption and the wear of the pump. The pump is regulated by tuning the flow rate of the air. For a proper operation at the lower performance range the regulation via a needle valve is recommended. An empty pump has to be driven slowly (e.g. via a needle-valve). The pump starts automatically. Pumps of the AH series are self-priming when dry, thus it is not necessary to fill the suction line of the pump. The suction lift capacity of a liquid-filled pump, however, is much higher. The pump is appropriate for running dry during slow operation. Dry running at high stroke frequency causes premature wear. The pumps can briefly (up to max. one hour) be operated against a closed discharge line. Throttling on the suction side may damage the pump. When the pump operation has been stopped by a closed discharge, the pressure equilibrium of the diaphragms must be ensured. This can be achieved by keeping the pump connected to the air supply pressure; for longer stoppage, the pump must be released from the pressure within the system on both fluid side and air supply side.

The ideal combinative effect of ALMATEC high pressure pumps and filter presses is illustrated very well by the automatic adaptation to pressure and flow rate. When beginning to fill the empty press, the low discharge pressure results in a high flow velocity for fast filling. Because of the pressure of the press increasing along with the amount of sludge inside, the flow rate of the pump automatically reduces until standstill at final pressure without any regulating or additional security devices. In contrast to a mechanically driven diaphragm pump, the ALMATEC high pressure pump stops itself without any further air consumption. This "integrated" automatic regulation permits operating the pump within its capacity without any danger of over-pressure.

3.3. Further safety hints



- Installation, operation, and maintenance by qualified staff only.
- Before start-up of the pump anyone should acquaint oneself with the explanations of the chapter troubleshooting (see pages 18/19). Only by this the defect quickly can be realized and eliminated in case of trouble. Problems which cannot be solved or with an unknown reason should be passed on to the manufacturer.
- Before any maintenance and service procedures arising on the pump or on the optional equipment, the complete installation has to be turned off and protected against accidental turn on. This is possible by a lockable emergency stop for the air supply of the pump. Additional a danger sign against restart should be attached.
- Pressure tests of the plant a pump is included in may only be carried out with the pump disconnected from the pressure on both ports or by using the pressure the pump develops while operating. The load of a pressure in the plant may damage the pump.
- AODD pumps must not be operated with a positive suction pressure.
- Depending on the conditions of operation, the liquid conveyed might escape from the pump through the muffler in case of a diaphragm rupture (in this case muffler has to be replaced). For further safety requirements the optional equipment diaphragm monitoring and barrier chamber system are recommended.
- In case of a diaphragm rupture, it might be possible for the fluid pumped to intrude into the air side of the pump. In very adverse conditions - e.g. pressure within the fluid system during stopped air supply - the fluid might as well find its way into the air supply lines. To protect other devices like pneumatic valves, it is recommended to protect the air supply line accordingly, e.g. via a non-return valve. This would as well avoid polluting the air supply line.
- The state of the muffler has to be inspected regularly, as a blocked muffler can be forced out of the pump. If this happens, damages of properties and/or persons cannot be excluded.



- Pumps of the AH-Series must not be submerged.
- When blowing out the filter press, the pump has to be protected against the pressure by a valve or a slide.
- If the product tends to settle, the pump has to be flushed regularly. For larger solids a filter has to be installed in the suction line.
- In case of delivery of hot liquids the wetted pump must not standstill for a longer time, because it could lead to temporary leaks in the valve area and to a blockade of the air control system.
- The relevant effective security advises have to be respected.
- Pools of liquid which appear in the near outer area of the pump have to be inspected on danger potential, if necessary safety measures are to be taken.
- Chemical and biological reactions in the product chamber of the pump (mixture of different substances) and the freezing of the liquid have to be avoided.
- Before starting to disassemble the pump, take care that the pump has been emptied and rinsed. Both ports piping are to be closed and drained if applicable. Further the pump has to be cut off from any energy on the air and product side. If the pump is being deported from the plant, a reference about the delivered liquid has to be attached.
- Please respect the relevant additional security advices, if the pump has been used for aggressive, dangerous or toxic liquids (e.g. suitable protective equipment according to the safety data sheet of the liquid). In case of a diaphragm rupture, it is possible that residues of the liquid remain behind the diaphragms, in the area of the air control system and at the muffler, despite of several flushing processes. Hence, appropriate safety equipment according to the safety data sheet of the liquid is indispensable.
- Before putting the pump back into operation, the tightness of the pump has to be checked.
- Air-operated diaphragm pumps can lead to bruises when lifting, sinking or assembling them. Appropriate accessories and safety equipments are to be used. Big and heavy modules have to fixed and secured to lifting gears when transporting/replacing them.
- Especially when deliver critical liquids, wear parts, like diaphragms, should be replaced within a preventive maintenance.
- The use of non-original ALMATEC spare parts and structural changes lead to the lapse of the warranty immediately. When operating such a pump, damages of properties and/or persons cannot be excluded.
- The operation of the pump with nitrogen as driving gas is possible. In closed rooms sufficient ventilation must be provided.
- Possible electrical connections (e.g. when using optional equipment with controllers) may be executed by a qualified person only. The regulations of the respective manufacturers are to be followed.
- At any work arising it has to be made sure that no explosive atmosphere can appear. Appropriate safety equipment is recommended.
- The pump is tested with water before shipment. Water residues inside the pump cannot be precluded. If the liquid, which is wanted to be conveyed, potentially interacts with water, please consult Almatec.
- Procedure for pump return: According to the requirements of our 14001-certification, every unit which is send to ALMATEC for diagnosis or maintenance reasons has to be accompanied by a filled out decontamination-sheet. Otherwise a processing is not possible. The decontamination-sheet is enclosed to this manual. Please pay attention to the further safety regulations.

3.4. Additional temperature hints

The temperature and pressure limitations listed on page 5 are solely based on mechanical temperature limits of the housing material used. Depending on the fluid pumped, the maximum safe operating temperature of the housing material can be reduced significantly.

A general aspect of lower temperatures is, that below 0°C (32°F) cold-brittling of the elastomers used within the pumps can results in accelerated wear. Regarding the housing materials, please note that PE - other than PP - keeps its mechanical strengths at low temperatures. ALMATEC pumps can therefore be operated safely as well within low-temperature installations: However, with liquids below 0°C (32°F) accelerated wear of internal parts has to be accepted. Moreover, freezing, bogging or crystallisation of the fluid pumped must be avoided, especially within the pump.

Please consider, that viscosity and specific gravity of most fluids change with temperature (most often increasing at lower temperature). Depending on the application, this fact may not only result in a reduced flow rate, the pump may even be unable to prime the thicker and/or “heavier” fluid any more.

In case of varying application temperatures, the housing bolt tension has to be controlled very thoroughly, as variations like these can change the effective tension of the housing bolts via the different thermal expansion characteristics of single.

3.5. Providing spare parts

We recommend having spare part kits S on stock. These include the relevant spare parts for your pump.

4. DISASSEMBLY OF THE ELEMENTS OF CONSTRUCTIONS

When dismantling a pump the mentioned procedures and safety notes on the pages 8-12 have to be considered generally.

ALMATEC high-pressure diaphragm pumps are often used to transport sludge, so that deposits and incrustations inside the pump can complicate the disassembly. It has been proved to be useful to soak the components before dismantling in water (if compatible with rinsing agent) to facilitate the separation after a certain waiting period.

The general design of the ALMATEC high pressure pumps is simple. Every pump comes along with a mounting tool for the air-valve system [22]. Take out the muffler [30] installed onto the center block [16] before dismantling the pump to protect it against damages during the disassembly.

	Required tools		AHD 15	AHD 25	AHD 40
Item	Description	Tool	Tool size	Tool size	Tool size
8	Lock pin, discharge valve	Screwdriver	Please check yourself		
10	Plug	Open-end spanner	30 mm	36 mm	50 mm
13	Housing bolt	Open-end spanner/ring wrench/socket wrench	10 mm	13 mm	17 mm
21	Air inlet	Open-end spanner	19 mm	27 mm	27 mm
22	PERSWING P® air control system	ALMATEC Tool + ring wrench	1 15 901 54 24 mm		

4.1. Pump housings and manifolds

At first, loosen those bolts [13] at the top and at the bottom using a wrench and take them out together with the tension plates [3]. After that, unscrew the remaining housing bolts [13], remove the tension discs [2] and draw the housing bolts [13] out to the left until they are left of the right hand side diaphragm [17]. Now, the right pump housing [1] can be taken away (if necessary carefully help it move with a rubber hammer). Draw out both manifolds [4] and remove the O-rings [11,12].

4.2. Suction and discharge valves

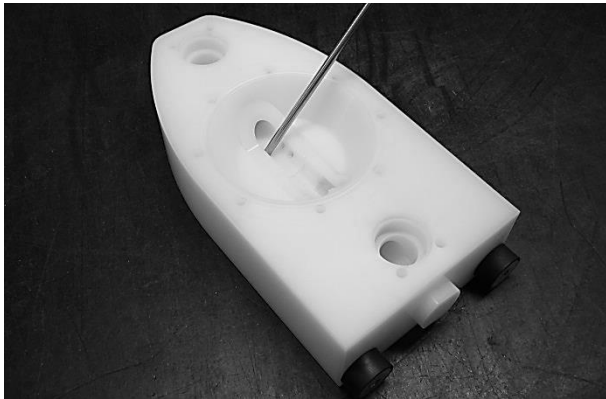

Image 1



Image 2

Lay down the pump housing [1] on its outer surface. Loosen lock pin discharge valve [8] and remove. Turn the discharge valve [7] along its longitudinal axis by 180° using a suitable round bar (Image 1). After ca. 70° change the bar to the other side of the discharge valve [7] (Image 2) and keep on turning the remaining 110°. Take care not to damage the sealing surface for the diaphragm (V-groove) during this. Draw the discharge valve [7] downwards and take it out (Image 3). Withdraw O-Ring, valve [40]. The discharge valve ball [18] can be taken out easily now. The valve stop [9] can be shoved downwards to take it out (Image 4).

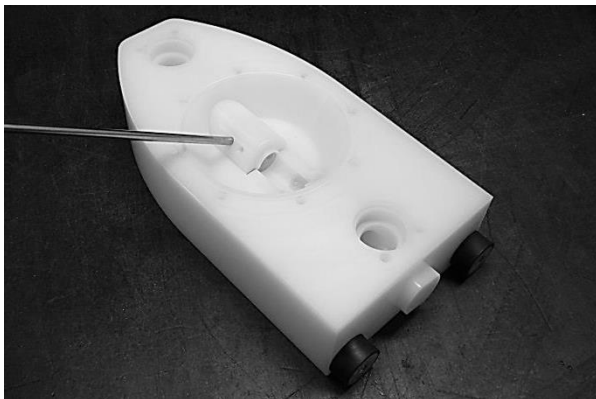

Image 3



Image 4

Unscrew the plug [10] out of the pump housing [1]. Use a suitable round bar (possible also is the shaft bushing long [39]) to press out the suction valve [5] from outside to inwards through the bore of the plug [10]. Take this as well as the suction valve ball [18] and the valve seat [6] out. Draw of O-ring, valves [40].

4.3. Diaphragms

After following the instructions above you will now have a unit consisting of the left pump housing [1] the center block [19] and the dual stage housing [15] with the housing bolts [13] partly torn out to the left.

To disassemble the diaphragms [17] reach behind the right diaphragm [17] and screw it off the shaft [32]. Take out the diaphragm disc [41] afterwards. Insert two long suitable screws (e.g. two housing bolts) into the threaded bores of the supporting disc [31] for approximately 10 mm (0.4 inch). Position a round bar as a handle in between them and loosen the supporting disc (do not yet screw off completely) (Image 5). Take the remaining housing bolts [13] out of the left pump housing [1] and remove the housing (disassembly of the suction and discharge valves as described above [4.2]). Turn off the left diaphragm [17] as well.

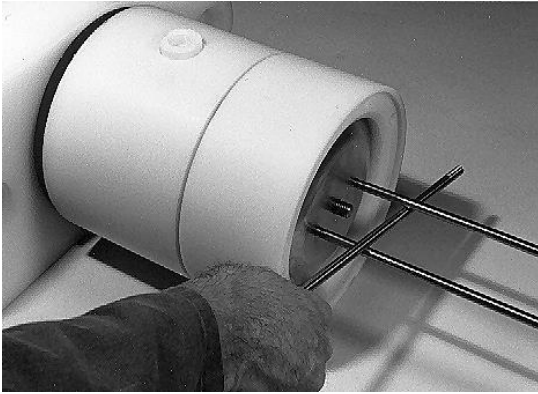

Image 5

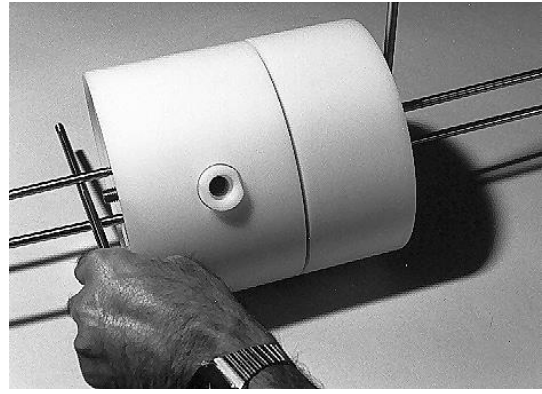

Image 6

Now, a supporting disc [31] is visible on each side which can be disassembled as follows: Screw two suitable screws (e.g. two housing bolts) as well approx. 10 mm deep into the threaded bores of the on the left side hand supporting disc [31]. Attach a round bar in between those to unscrew the supporting disc [31] on the right and to fix the other disc (Image 6). Shove the shaft [32] into the right side and unscrew the other supporting disc [31] as well. Take out the shaft [32] and separate the center block [19] and the dual stage housing [15]. Take care not to damage the O-Ring dual stage bushing [36] when disassembling the shaft [32], lead the thread through this O-Ring by screwing.

4.4. Dual stage housing

The dual stage housing [15] is the smaller of both blocks in the middle of the pump. Loosen the dual stage bushing [16] along with the dual stage piston [35] from the dual stage housing [15] and push the dual stage piston [35] out of the dual stage bushing [16]. Take out the shaft bushing, short [33]. The sealing elements [33,36,37,38] have to be replaced in case they are soiled or damaged. As far as the piston rings are concerned, we refer to their own chapter 4.5.1. within this manual.

4.5. Center block

Take the shaft bushing, long [39] out first and lay the center block [19] plainly onto a soft base (do not damage the sealing edges!).

4.5.1. Shaft piston rings

Remove both parts of the shaft piston rings [20] from their grooves carefully (do not damage the edges in the center housing) A re-assembly of the same piston rings is impossible; they have to be replaced. Handle the piston rings in the dual stage housing [15] the same way.

4.5.2. Air control system *PERSWING P*[®]

Screw off both end caps of the *PERSWING P*[®] air control system [22] using the plastic mounting tool delivered with the pump. Take out main and pilot piston. Press out the air-valve housing with the mounting tool turned around.

4.5.3. Air filter

To take out the air filter [29] the air inlet [21] has to be screwed off first, afterwards the filter [29] can be unscrewed easily with a big screw driver.

5. ASSEMBLY OF THE ELEMENTS OF CONSTRUCTION

5.1. Center block

5.1.1. Air control system *PERSWING P*[®]

To install the air control system *PERSWING P*[®] [22], first screw in one end cap flushly into the center block [19]. Insert one of the six O-rings, air-valve housing [24] into the end cap from the inside. Moisten the four O-rings [24] of the air-valve housing with a bit of water and push the housing into the center block [19] using the mounting tool. Take care that it slips in softly. Do never insert the housing violently with a hammer. In case the housing cocks or hardly gets in, take it out again completely and start again. Insert the main piston and the pilot piston. Lay the sixth O-Ring [24] on the edge of the air-valve housing and screw in the second end cap.

5.1.2. Shaft piston rings



The O-Rings located underneath the piston rings [20] have to be installed first. A re-assembly of the used piston rings is impossible; they have to be replaced! To assemble piston rings [20], carefully shape them like kidneys with locking ring pliers and insert the rings into the grooves; completely press the rings into the grooves smoothly using a clean housing bolt [13]. Insert the shaft bushing, long [39] on side of the center block where the big O-ring dual stage bushing [38] is located.

5.2. Dual stage housing

Install piston rings [rings and O-rings,20] as described. Insert the shaft bushing, short [33] on the side of the big O-ring dual stage bushing [38]. Insert the O-rings, dual stage bushing into their grooves in the dual stage housing [15] respectively the center block [19]. Lay the dual stage bushing [16] into the dual stage housing [15] and afterwards insert the dual stage piston [35] with the conic side at first (corresponding to the shape of the dual stage housing [15]) into the dual stage bushing [16].

5.3. Diaphragms

At first, the center block [19] and the dual stage housing [15] have to be put together and the shaft [32] has to be shoved in rotatingly with care. The threads on both sides of the shaft differ in their lengths. Screw the first supporting disc [31] onto the shaft [32] up to its block at the side where the thread is the shorter. Attach the other supporting disc [31] tightly on the other end and tighten the first disc as well (for tightening the discs, follow the disassembly instructions 4.3). Take the screws used for fixing (e.g. two housing bolts) out of the supporting discs [31]. Align the bore holes in center block [19] and dual stage housing [15]. Put on the diaphragm discs [41] on both sides.

Screw a diaphragm [17] on one side onto the shaft [32] until it blocks. Take care that the bore holes for the housing bolts are aligned between the diaphragm [17], the center block [19] and the dual stage housing [15]. Insert three housing bolts [13] carefully as an assembly auxiliary. Push the diaphragm [17] into the center block [19] resp. dual stage housing [15] as far as possible. Screw the second diaphragm [17] up to its block onto the other end of the shaft (watch out for all bores to be aligned, if necessary, slightly turn back the diaphragm). Shove in the remaining housing bolts [13] finally.

The sealing surfaces of the diaphragms [17] and the pump housings [1] have to be absolutely clean and undamaged; mere small scratches can cause leaking.

5.4. Suction and discharge valves

The inner parts of the pump housings [1] have to be re-assembled exactly vice versa to the way described for the disassembly. Ensure that the suction [5] and discharge valves [7] are pushed into their extreme position and that the bores in the pump housings [1] (at the bottom of the liquid camber) and the suction valves [5] fit to each other. Make sure that the hole in the pump housing [1] and the thread of the locking pin discharge valve [8] are aligned, then install locking pin discharge valve [8] in the discharge valve [7] and screw it.

5.5. Housing bolts with spring washers

AHD 15-25

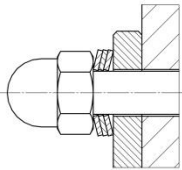

AHD 40

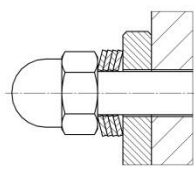

When assembly the housing bolts [13] pay attention to the correct arrangement of the spring washers. The pump sizes AHD 15 / AHD 25 have three spring washers on both housing bolt sides and the AHD 40 have four pieces. The arrangement represented in the drawings makes an improvement of power and way possible. Already used spring washers may not be installed again.

5.6. Pump housings and manifolds

All the sealing elements [11,12] of the manifolds [4] should always be replaced, moisturising the rings helps to ease the assembly. Draw the inner O-ring [12] onto the manifold [4] and press the outer O-ring [11] into the pump housing [1]. Set the manifolds [4] on the plainly lying pump housing [1] slightly rotating them. Put the central unit mounted before [center block, dual stage housing, diaphragms, housing bolts] and the pump housing [1] lying on its side with the manifolds [4] standing upwards together, namely in the way that the air inlet [21] ends up right of the dual stage housing [15].

Mount the second pump housing [1]. Now, both the upper and lower pair of housing bolts [13] can be inserted. Make sure that the position of the manifolds [4] matches the installation situation, to avoid later readjustment. Install tension discs [2] and tension plates [3]. Attach nuts and washers to the ends of the bolts and fix the housing bolts [13] crosswise evenly according to the given torque values until the pump housings [1] are situated on the center block [19] respectively the dual stage housing [15]. Any further tightening of the bolts does not improve sealing but can deform the housing!

Finally screw the muffler [30] into the center block [19]. The pump can be operated now.

6. TESTING ADVISES

6.1. Air control system

The correct function of the air distribution can easily be checked for an assembled center unit consisting of a center block [19] completely and dual stage housing [15] equipped with all inner parts. Attach the air supply. Move the pilot piston back and forth while the bores where the air leaves the center block [19] are blocked. Now, the switching and the movement of the main piston have to be audible.

6.2. Correct function and sealing

The fully assembled ALMATEC high pressure pump has to be equipped with an air supply as well as temporary suction and discharge lines both leading to a water containment. The dry suction capacity can be checked with a vacuum gauge by closing the suction line carefully complete. Slowly closing the discharge has to cause standstill of the pump. The pressure in the discharge line has to correspond to the air pressure (Attention: the maximum permissible air pressure is 7 bar / 100 psig; which evokes a max. operating pressure of 15 bar / 218 psig!). The pump switches to the other product chamber by scarcely opening the discharge for a short time. No liquid may escape from the pump in both positions. After finishing the test, the air supply has to be closed at first, after that the discharge line has to be opened slowly to let the pump empty itself while the suction line is opened.

7. TROUBLESHOOTING

Malfunction	Possible Reason	Solutions/Remarks
pump does not operate	air supply line blocked/closed muffler blocked working chambers blocked air control system defective discharge line blocked/closed	open air supply clean/replace muffler remove blockage replace air valve system clean/open line
pump operates unsteadily	piston rings worn air control system worn diaphragm rupture air control system soiled check valve blocked icing	replace piston rings replace air control system replace diaphragm, clean pump clean/replace air control system cleaning, removal of bulk particles improve air processing
air within liquid	suction line leaky container with liquid empty diaphragm rupture cavitation	seal suction line fill/new container replace diaphragm adapt suction lift, possibly install suction pressurised air chamber
insufficient discharge pressure	insufficient pressure/amount of driving air air supply line leaky air control system leaky check valve worn more air consuming components	increase air supply check/repair air supply replace air control system check/replace check valve increase pressure/amount of air
output decreases	air control system soiled icing air pressure drop suction line/inlet strainer soiled discharge line/outlet strainer soiled muffler blocked check valve worn change in viscosity more air consuming components	clean/replace air control system improve air processing: dryer/filter ensure sufficient supply of air cleaning cleaning replace the muffler replace valve change back/adjust pump increase pressure/amount of air
pump stops itself	icing of the air control system air pressure too low air pressure drop discharge line blocked air filter blocked valve closed air control system defective wear/leaking of air control system diaphragm rupture check valve blocked/worn	improve air processing: dryer/heater etc. increase air pressure ensure sufficient air supply clean discharge line clean air filter open valve replace air control system replace air control system replace diaphragm, clean pump clean/replace check valve

Malfunction	Possible Reason	Solutions/Remarks
pumps operates, however suction capacity insufficient	pump operates too fast operation beyond physical limits cavitation operation beyond pump capacity air cushion within suction/discharge line dry suction against discharge pressure valve filter within suction line closed valve filter within discharge line closed container with liquid empty vacuum inside the container wear of the check valves suction line leaky suction line blocked air pressure cushion at discharge check valve blocked	start more slowly adjust installation check, cool down adjust installation resp. install bigger pump bleed the line wet pump, start without pressure open valve/clean filter open valve/clean filter fill/new container bleed container replace valves seal suction line clean suction line bleed discharge line clean/replace valve
insufficient suction capacity after pump repair	connections tighten incompletely check valves inserted falsely	tighten/seal connections correct positioning of check valves
diaphragm overstrained	pressure within the plant/system inadmissible vacuum icing	ensure that pressure is only developed by the pump itself, check plant/valves, replace diaphragms check suction line, open valve improve air processing
leaking between housing parts	housing bolts loosened O-rings sleeve damaged diaphragms attacked chemically diaphragms overstrained tension installation/pipework	tighten bolts, check pump replace O-rings replace diaphragms replace diaphragms loosen, eliminate tension, use of a compensator
muffler grey	driving air too humid, icing	improve quality of driving air
muffler black	soiled, oily air	improve quality of driving air, install sensitive filter in suction line
pump is connected to air but does not operate	air control system blocked bulk particles/dirt chemical influence (O-rings swollen) valve closed in discharge line	clean/replace air control system clean pump, replace necessary parts, improve air quality check, replace damaged parts open valve
liquid leaves the pump via the muffler	diaphragm rupture	replace diaphragms, clean pump

8. SPARE PART LIST

Pump size				AHD 15	AHD 25	AHD 40
Item	Pc.	Description	Material	Part number	Part number	Part number
1	2	Pump housing	PE	3 15 510 52	3 25 510 52	3 40 510 52
2	2	<i>Tension disc</i>	1.4301	3 15 508 22	3 25 508 22	3 40 508 22
3	4	<i>Tension plate</i>	1.4301	3 15 608 22	3 25 608 22	3 40 608 22
4	2	Suction/discharge port	PE	3 15 511 52	3 25 511 52	3 40 511 52
5	2	Suction valve	PE	3 15 013 52	3 25 013 52	3 40 013 52
6	2	Suction valve seat	PE	3 15 014 52	3 25 014 52	3 40 014 52
7	2	Discharge valve	PE	3 15 515 52	3 25 515 52	3 40 515 52
8	2	Lock pin, discharge valve	PETP	3 15 519 84	3 15 519 84	3 40 519 84
9	2	Ball retainer	PE	3 15 016 52	3 25 016 52	3 40 016 52
10	2	Plug	PE	1 25 017 52	3 25 017 52	1 40 017 52
11	4	<i>O-Ring, ports, outside</i>	EPDM	9 37 528 72	9 42 540 72	9 65 516 72
12	4	O-Ring, ports, inside (code EEE/ENN)	EPDM	9 33 526 72	9 33 526 72	9 51 513 72
		O-Ring, ports, inside (code ETT)	FEP/FKM	9 33 553 59	9 33 553 59	9 50 554 59
13	12	<i>Housing bolt</i>	1.4301	3 15 520 22	3 25 520 22	3 40 520 22
14	4	<i>Shock absorbers</i>	NR	1 15 322 85	1 15 322 85	1 40 322 85
15	1	<i>Dual stage housing</i>	PA	3 15 148 53	3 25 148 53	3 40 148 53
16	1	<i>Dual stage bushing</i>	PETP	3 15 049 84	3 25 049 84	3 40 049 84
17	2	Heavy duty diaphragm (code EEE)	EPDM	3 15 031 72	3 25 031 72	3 40 031 72
		Heavy duty diaphragm (code ENN)	NBR	3 15 031 71	3 25 031 71	3 40 031 71
		Heavy duty diaphragm (code ETT)	PTFE	3 15 031 67	3 25 031 67	3 40 031 67
18	4	Valve ball (code EEE)	EPDM	1 25 032 72	3 25 032 72	3 40 032 72
		Valve ball (code ENN)	NBR	1 25 032 71	3 25 032 71	3 40 032 71
		Valve ball (code ETT)	PTFE	1 25 032 60	3 25 032 60	3 40 032 60
19	1	<i>Center block</i>	PA	3 15 140 53	3 25 140 53	3 40 140 53
20	3	<i>Shaft piston ring, cpl.</i>	PTFE	1 40 041 64	1 50 041 64	3 40 041 64
21	1	<i>Air inlet</i>	PETP	1 15 047 84	1 40 047 84	1 40 047 84
22	1	<i>PERSWING P® air control system, cpl.</i>	PETP	2 15 001 84	2 40 001 84	2 50 001 84
24*	6	<i>O-ring, air valve housing</i>	NBR	9 35 504 71	9 46 515 71	9 66 533 71
29	1	<i>Air filter</i>	PE	1 15 043 51	1 40 043 51	1 40 043 51
30	1	<i>Muffler</i>	PE	1 15 244 51	1 40 244 51	1 50 244 51
31	2	<i>Supporting disc</i>	AL	3 15 533 31	3 25 533 31	3 40 533 31
32	1	<i>Shaft</i>	1.4301	3 15 030 22	3 25 030 22	3 40 030 22
33	1	<i>Shaft bushing, short</i>	1.4301	3 15 035 22	3 25 035 22	3 40 035 22
34	2	<i>O-ring, shaft bushing</i>	NBR	9 24 514 71	9 30 510 71	9 36 591 71
35	1	<i>Dual stage piston</i>	AL	3 15 034 31	3 25 034 31	3 40 034 31
36	1	<i>O-ring, dual stage piston</i>	FKM/NBR	9 10 507 74	9 12 506 71	9 17 557 74
37	1	<i>Piston ring, cpl.</i>	PE	3 15 037 52	3 25 037 52	3 40 037 52
38	2	<i>O-ring, dual stage bushing</i>	NBR	9 99 567 71	9 99 562 71	9 99 573 71
39	1	<i>Shaft bushing, long</i>	1.4301	3 15 036 22	3 25 036 22	3 40 036 22
40	4	O-ring, valves (code EEE/ENN)	EPDM	9 37 603 72	9 48 604 72	9 72 605 72
		O-ring, valves (code ETT)	PTFE	9 37 603 60	9 48 604 60	9 72 605 60
41	2	<i>Diaphragm disc</i>	PTFE	3 15 039 60	3 25 039 60	3 40 039 60

* included in item 22

All parts in italics are not product wetted.

Please see page 4 for explanation of the pump code.

When ordering please state the serial number of the pump.

For spare part lists for special equipment please see page 22 and the following ones.

9. EXPLODED VIEW

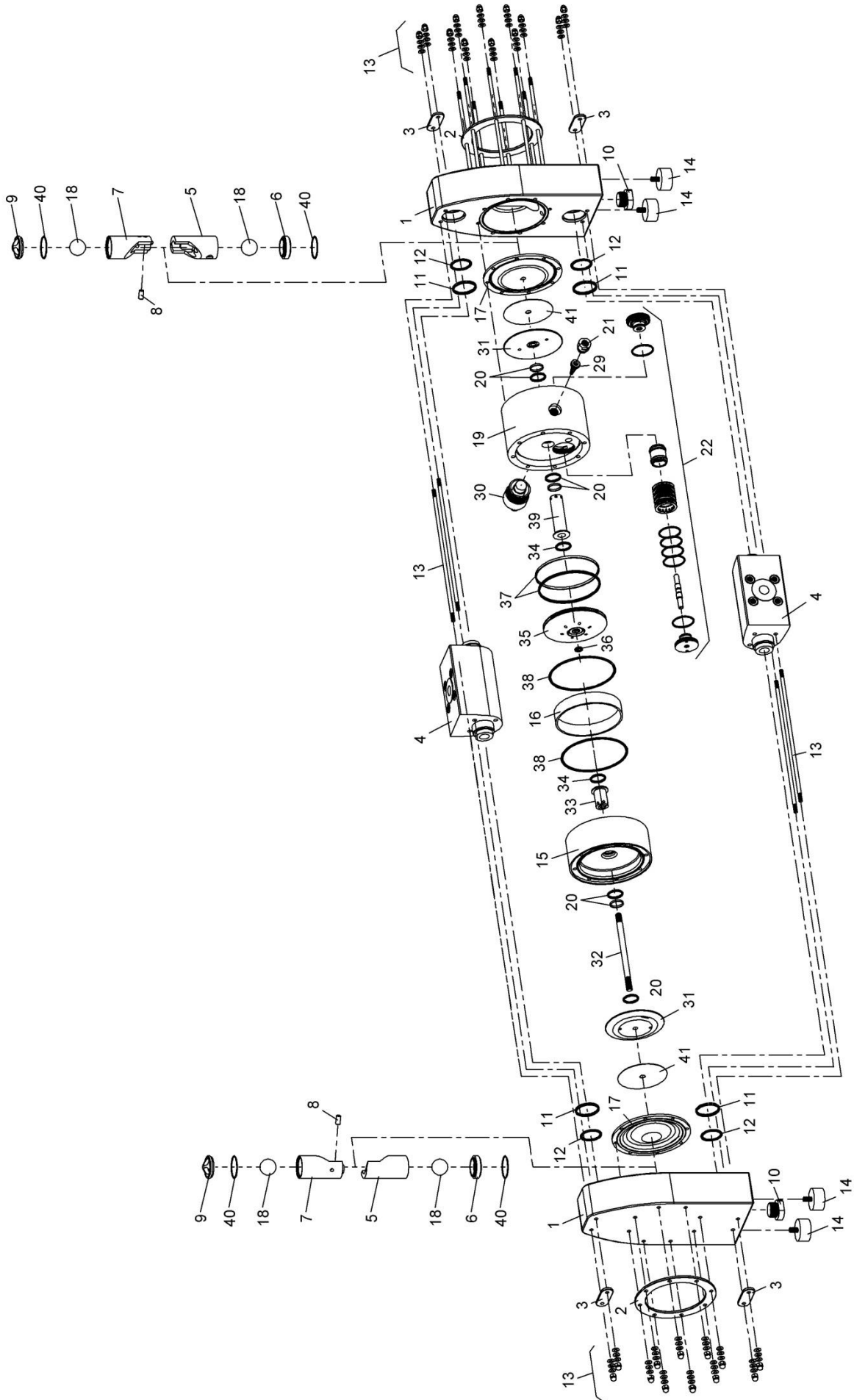

10. OPTIONAL EQUIPMENTS

ALMATEC high pressure diaphragm pumps are available with various optional equipments. Whether the pump is equipped with options can be derived from the pump code.

10.1. Stroke counting (optional equipment code C)

10.1.1. Code C 2 / C 3 – capacitive stroke detection

A sensor [50] is installed in the center block [19] of the pump to count the strokes. The diaphragm movement is scanned without contact by this sensor: a safe form of monitoring totally independent of external influences and the pump's mode of operation. The issued sensor pulses can be output to existing detectors or to a stroke counter (can also be supplied). When the preset value is reached, the stroke counter outputs a signal which can then be processed further, for instance in order to shut down the pump via a solenoid valve.

The stroke counting system is available in two variations:

- C 2 Stroke sensor (Namur), also for explosion-proof zone
- C 3 Stroke counting system complete with sensor and stroke counter

In case only the sensor is included (code C 2), it has to be connected to an existing controller with Namur inlet. The wiring diagram and technical data can be found on the electric units themselves. For further details, please refer to the data delivered by the manufacturers of the components. The controllers have to be installed in a suitable cabinet.

10.1.2. Code C 9 / C 10 – pneumatical stroke detection

Differently from the optional equipment codes C 2 - C 3, the strokes of the pump are registered pneumatically on the codes C 9 / C 10. The pressure switch registers the changes in pressure within the air chamber behind one of the diaphragms and it converts the pneumatic impulse into an electrical signal.

The pneumatic stroke counting system is available in two types:

- C 9 consist of:
 - pressure switch, cpl. mounted, 1 – 10 bar
 - socket with cable 5 m
 - adaptor elbow NPT ¼ (or adaptor straight for pump sizes AHD 15)
 - hose DN 4/6, 2,5 m
- C 10 consist of:
 - as C 9 and a stroke counter

For assembly screw the adaptor elbow (or adaptor straight for pump size AHD 15) into the additional air connection of the pump (it is possible that the adaptor is already installed). The position of the air inlet of the pneumatic stroke counting is above the air inlet of the pump (do not mistake it). Link up the adaptor and the pressure switch with the hose. Connect the socket to the electrical connection plug of the pressure switch and the cable to existing registering devices (code C 9) resp. to the enclosed stroke counter (code 10). Technical data, connection schemes and further details can be found in the technical documentation delivered by the manufacturers of the pressure switch and the stroke counter.

The pneumatic stroke counting system requires a minimum air pressure of 1.5 bar (22 psig) for optimal function!

10.2. Diaphragm monitoring (optional equipment code D)



Although ALMATEC diaphragms with integrated metal core are designed for an optimum service life, the diaphragm remains a wear part. If it breaks, liquid can leak into the center housing and possibly emerge through the muffler. This can be prevented simply and effectively with the ALMATEC diaphragm monitoring.

A capacitive diaphragm sensor is mounted in the muffler [30] of the pump, which registers any liquid approaching the sensor, no matter whether the liquid is conductive or not. Hence, a fast reaction to a damage of a diaphragm becomes possible. However, it has to be considered, that the diaphragm monitoring possibly cannot prevent that liquid can leave the pump via the muffler. In case of humid surrounding air a false alert may occur despite operating the pump with dried compressed air.

The diaphragm monitoring is available in two variations:

- D 1 Diaphragm sensor (Namur), also for explosion proof area
- D 3 Diaphragm monitoring complete with sensor and controller

The diaphragm sensor can either be connected to an existing controller with Namur inlet (code D 1) or to the controller included (code D 3). The wiring diagram and technical data can be found on the controller itself. For further details, please refer to the data delivered by the manufacturers of the components. The controllers have to be installed in a suitable cabinet.

10.3. ANSI flange connections (optional equipment code W)

As standard the connections in the suction and discharge ports [4] are prepared for a DIN flange connection (PN 16), but it is possible to order a preparation for ANSI flange connection (300 lbs) also.

10.4. Spare part list optional equipments

Pump size					AHD 15	AHD 25	AHD 40
Code	Item	Pc.	Description	Material	Part number	Part number	Part number
C 2	16	1	Center block for sensor	PA	3 15 340 53	3 25 340 53	3 40 340 53
	50	1	Stroke sensor, Namur	diverse	1 00 072 99	1 00 072 99	1 00 072 99
C 3	-	1	as C 2, but additional: Clamp amplifier	diverse	1 00 171 99	1 00 171 99	1 00 171 99
	-	1	Stroke counter	diverse	1 00 071 99	1 00 071 99	1 00 071 99
	-	-					
C 9	16	1	Center block with additional air connection R 1/4"	PA	3 15 440 53	3 25 440 53	3 40 440 53
	-	1	Adaptor straight	PP	1 00 877 51	-	-
	-	1	Adaptor elbow	PP	-	1 00 875 51	1 00 875 51
	-	1	Hose	PE	1 00 876 51	1 00 876 51	1 00 876 51
	-	1	Pressure switch	diverse	1 00 972 99	1 00 972 99	1 00 972 99
	-	1	Socket with cable	diverse	1 00 973 99	1 00 973 99	1 00 973 99
C 10	-	1	as C 9, but additional: Stroke counter	diverse	1 00 071 99	1 00 071 99	1 00 071 99
D 1	51	1	Diaphragm sensor, Namur	diverse	1 00 773 99	1 00 773 99	1 00 773 99
D 3	51	1	Diaphragm sensor	diverse	1 00 773 99	1 00 773 99	1 00 773 99
	-	1	Controller	diverse	1 00 370 99	1 00 370 99	1 00 370 99
W	4	2	ANSI suction/discharge ports	PE	3 15 711 52	3 25 711 52	3 40 711 52



Subject to change without notice, 2018/11