

APPLICATION:

Mono-cell scales whose platform is up to 400mm x 400mm

CAPACITY RANGE:

10kg - 30kg - 50kg - 100kg

MATERIAL:

Stainless Steel

ENVIRONMENTAL PROTECTION:

IP67

APPROVALS:

CE 3000 Div - TC6178

OIML 3000 Div - R60/2000-NL 1-03.03

CHARACTERISTICS

Manufactured in stainless steel. Only 25mm high.

High quality protection barrier using special silicones.

Mounting compatibility.

APPLICATIONS

The IBM model is specially designed for platforms up to 400mm x 400mm with low profile and is protected from environmental conditions that appear in industry, where work and cleaning require a good environmental protection.

OPTIONS

Sensitivity alignment: $\pm 0,1\%$.

Length of the cable is optional.

Hostile environmental cable.

Consult for special requirements.

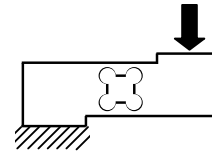
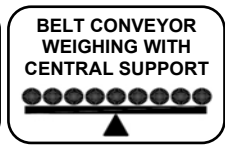
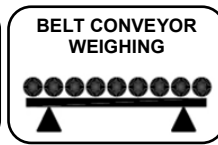
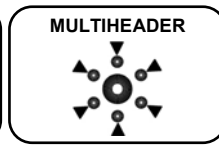
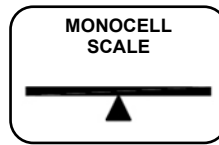

TEFLÓN® protects all the internal cables

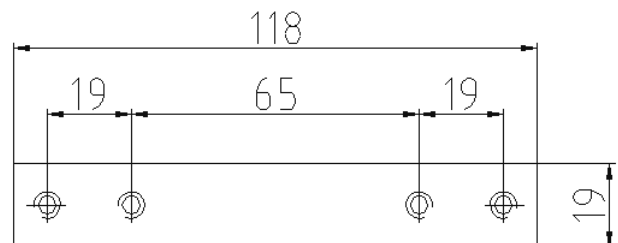
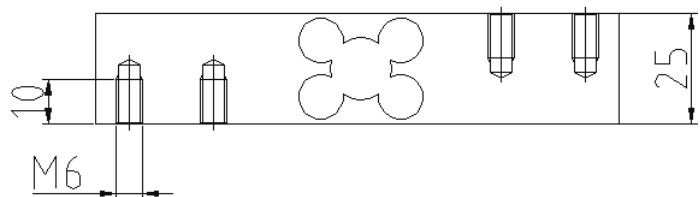

Dimensions in mm

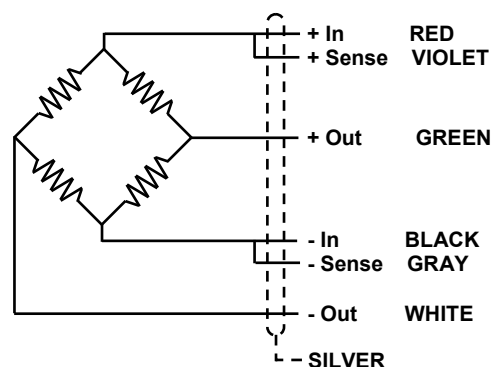

GENERAL TECHNICAL CHARACTERISTICS FOR $g = 9,8031 \text{ m/s}^2$

OIML Class	C3	UNITS
Divisions n_{LC}	3000	
Minimum Dead load E_{min}	0	kg
$Z = E_{max} / 2DR$	3000	
$Y = E_{max} / V_{min}$	10000	
Rated Capacity E_{max}	10 - 30 - 50 - 100	kg
Rated Sensitivity C	$2 \pm 10 \%$	mV/V
Rated Input Voltage	10	V dc
Input Voltage Range	5...15	V ac/dc
Input Resistance R_{LC}	382 ± 10	Ω
Output Resistance	350 ± 3	Ω
Zero Balance	± 2	% Emax
Insulation Resistance at 50 V DC	> 5000	M Ω
Service Overload	> 150	% Emax
Overload Limit	> 300	% Emax
Temperature Range : Compensated	- 10 ... 40	$^{\circ}\text{C}$
: Operating	- 30 ... 85	$^{\circ}\text{C}$
: Storage	- 30 ... 90	$^{\circ}\text{C}$
Max. Nonlinearity	0,02	% Emax
Max. Hysteresis	0,02	% Emax
Max. No repeatability	0,01	% Emax
M Max. Creep in 4 hours	0,03	% Emax
Max. Zero Recovery Test in 1/2 hour	0,011	% Emax
Max Temperature effect : On Sensitivity	0,0013	% Emax / $^{\circ}\text{C}$
: On Zero	0,0014	% Emax / $^{\circ}\text{C}$
Weight	360	g
Cable Length	3	m
Environmental Protection	IP67	