



EPTDA
Member



SPIDEX® – die elastische Kupplung
SPIDEX® – the elastic coupling

DENTEX®/DENTEX® FL – die flexible Kupplung
DENTEX®/DENTEX® FL – the flexible coupling

SPIDEX® – die elastische Kupplung SPIDEX® – the elastic coupling

- Drehelastisch
- Schwingungsdämpfend
- Axial steckbar
- Durchschlagsicher
- Wartungsfrei
- Nabenwerkstoffe:
Aluminium (Al), Aluminium Druckguss (ALU),
Grauguss (GG), Sphäroguss (GGG), Sinterstahl (Si),
Stahl (St)

- Torsional elasticity
- Damping
- Blind assembly
- Safe against breakdown
- No maintenance
- Hub material:
aluminium (Al), die-cast aluminium (ALU),
cast iron (GG), SG iron (GGG), sintered steel (Si),
steel (St)



SPIDEX® – die elastische Kupplung

SPIDEX® – the elastic coupling

Funktionsweise

Technical description

Elastische Kupplungen sind in der Lage, kurzzeitige Drehmomentstöße durch zeitweilige elastische Speicherung eines Teiles der Stoßenergie zu mildern. Der Ungleichförmigkeitsgrad der Bewegungs- und Drehmomentübertragung wird somit kleiner. Elastische Kupplungen dämpfen den Körperschall und tragen somit zur Geräuschminderung bei. Die elastische SPIDEX®-Kupplung überträgt das Drehmoment formschlüssig und durchschlagsicher. Der ballig profilierte Evolventenzahn (Abb. 1) gestattet den Ausgleich von Radial- und Winkelverlagerungen der zu verbindenden Wellen. Er besteht aus einem thermoplastischen Polyurethan-Elastomer, ist ausschließlich auf Druck belastet und zeichnet sich darüber hinaus durch hohe Verschleißfestigkeit und Elastizität, gute Dämpfungseigenschaften und gute Beständigkeit gegen Öle, Fette, viele Lösemittel, Witterungseinflüsse und Ozon aus. Hinzu kommt eine gute Hydrolyse- und Tropenbeständigkeit.

Die Einsatztemperaturen liegen zwischen -40 °C und $+100\text{ °C}$ in der Standardausführung. Kurzzeitige Temperaturspitzen bis $+120\text{ °C}$ sind zulässig. Für Einsatztemperaturen im Bereich deutlich über $+100\text{ °C}$ bis $+150\text{ °C}$ ist die Zahnkranz-Serie TPS entwickelt worden (Seite 12).

Die Standardhärte des Zahnkranzes beträgt 92° Shore A . Für höhere Drehmomente können auch Zahnkränze mit 95° und 98° Shore A und für hohe Drehmomente ein Zahnkranz mit 64° Shore D eingesetzt werden, dieser ist sehr hart und hat eine geringe Dämpfung. Durch die aus Abb. 1 und Abb. 2 zu ersehende Balligkeit nehmen die Zähne des Zahnkranzes mit zunehmender Verformung eine überproportional wachsende Verformungsenergie auf (Seite 5). Der Wert der Federsteife CT des Zahnkranzes nimmt mit Vergrößerung des relativen Drehwinkels φ zu. Folglich arbeitet die Kupplung bei geringer Drehmomentübertragung relativ weich und mit zunehmendem Drehmoment immer härter. Hieraus ergibt sich eine progressive Federkennlinie gemäß Abb. 3. Die dynamische Federkennlinie hat einen geringfügig steileren Verlauf.

Die in Abb. 3 dargestellte Dämpfungsarbeit bewirkt die in Abb. 4 ersichtliche Dämpfung von Drehmomentstößen.

Ein besonderer Vorteil der progressiven Federkennlinie liegt im Resonanzverhalten der SPIDEX®-Kupplung. Da die kritische Resonanzdrehzahl abhängig von der Federsteife CT ist, letztere sich jedoch mit Verschiebung des Arbeitspunktes ändert, ergibt sich eine Verstimmung des Systems gemäß Abb. 5, welche die Gefahr des Aufschaukelns verringert.

Die progressive Kennlinie schützt somit vor allem die Kupplung gegen unzulässige Überbeanspruchung. Darüber hinaus kann die Federsteife CT durch eine entsprechende Wahl der Shorehärte beeinflusst werden. Eine größere Shorehärte verlagert die Resonanzdrehzahl in einen höheren, eine niedrigere Shorehärte in einen niedrigeren Bereich. Im Zweifelsfalle empfehlen wir eine Berechnung des Systems mittels der antriebs- und lastseitigen Massenträgheitsmomente.



Elastic couplings reduce intermittent short-period torsional shocks by briefly storing part of this shock energy elastically. Any degree of uneven movement and torque transference is consequently reduced. Elastic couplings suppress body resonance and therefore contribute to noise reduction. The elastic SPIDEX® coupling transmits the torque without the risk of breakdown and backlash-free. The convex generated profiled tooth crown, see Fig. 1, allows compensation of radial and angular displacements of the two connected shafts. It consists of a thermoplastic polyurethane elastomer that is loaded exclusively under pressure, designed for high abrasion resistance and elasticity, has good damping characteristics, is resistant to oils, greases, many solvents, atmospheric effects and ozone, as well as having a good resistance to hydrolysis in tropical conditions.

The operating temperature range is between -40 °C and $+100\text{ °C}$. Short temperature peaks up to $+120\text{ °C}$ are admissible. The TPS spider series (see p. 12) was developed for operating temperatures that are constantly well above $+100\text{ °C}$ to $+150\text{ °C}$.

The standard hardness of the spider is 92° Shore A . For higher torques, a spider of 95° to 98° Shore A can be used, and for high torques a spider with 64° Shore D , which is extremely hard and has a low damping effect. As Figures 1 and 2 show, the convex rim of the tooth absorbs a higher proportion of deformation energy as deformation increases (see p. 5). The torsional rigidity value CT of the tooth crown increases with the torsional angle φ . Consequently, the coupling is relatively soft under small load conditions and becomes progressively harder as the torque increases. This causes a progressive torsion curve, as shown in Fig. 3. The dynamic torsion curve has an insignificantly steeper course.

The damping energy shown in Fig. 3 results in the damping of torque shocks as shown in Fig. 4.

The special advantage of the progressive torsion characteristic is the resonance suppression achieved by the SPIDEX® coupling, as the critical resonance speed depends on the torsional rigidity CT (see Fig. 5).

The progressive curve therefore mainly protects the coupling against inadmissible overstressing. Furthermore, the torsional rigidity CT of the spider can be influenced by the choice of an appropriate Shore hardness material. A larger Shore hardness moves the resonance speed higher, and a lower Shore hardness moves resonance speed into a lower range. If in doubt, we recommend a calculation of the systems dynamics by using the moments of inertia of the driving and driven sides.

Abb. 1
Unbelasteter Polyurethan-Zahn

Fig. 1
Unloaded polyurethane tooth



Abb. 2
Belasteter Polyurethan-Zahn

Fig. 2
Loaded polyurethane tooth

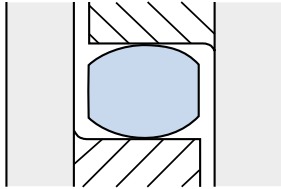

Abb. 3
Progressive Drehfederkennlinie mit Hystereseschleife

Fig. 3
Progressive torsion spring curve with hysteresis loop

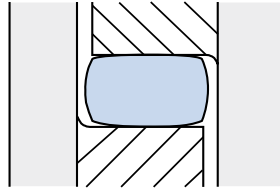

Abb. 4
Vergleich Drehmomentstoß mit und ohne Dämpfung

Fig. 4
Comparison of torque peak with and without damping

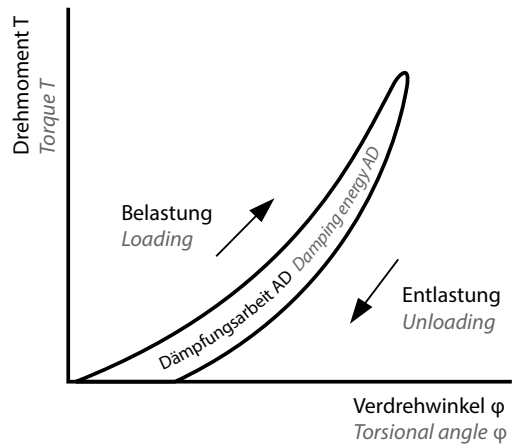

Abb. 5
Resonanzverhalten elastischer Kupplungen mit linear und progressiv ansteigender Drehfederkennlinie

Fig. 5
Resonance suppression of elastic couplings with linear and progressively increasing torsional characteristic

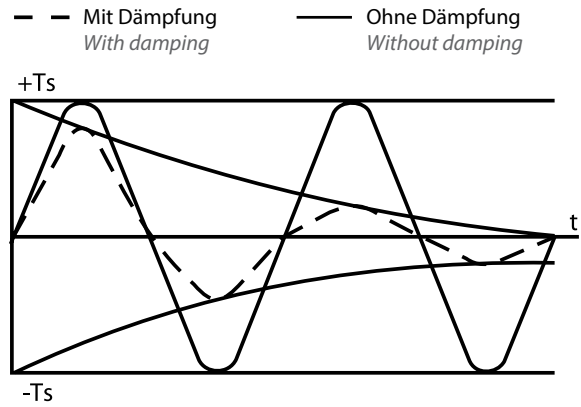
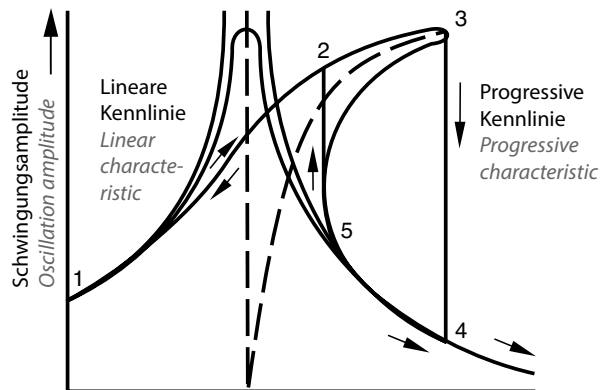

Auswahlprozess zur Größenbestimmung Selection process for sizing determination

Schritt 1: Bestimmung des Nenndrehmoments Ihrer Anwendung:

$$T_N \text{ [Nm]} = \frac{P \text{ [kW]} \times 9550}{U \text{ /min [1/min]}}$$

Schritt 2: Berechnung des Betriebsfaktors Ihrer Anwendung mit der Tabelle auf Seite 7.
Der Gesamtbetriebsfaktor (K) ergibt sich aus:

$$K = K1 \times K2 \times K3$$

Schritt 3: Berechnung des konstruktiven Drehmoments (T_{NK}) Ihrer Anwendung:
Konstruktives Drehmoment (T_{NK}) =
Nenndrehmoment (T_N) x Betriebsfaktor (K).

Schritt 4: Unter Verwendung der Elastomer-Leistungsdatentabellen auf der Seite 11 den Urethan-Shore-Härtegrad auswählen, der am besten den relativen Dämpfungsanforderungen Ihrer Anwendung entspricht.

Schritt 5: Finden Sie als nächstes die Spalten, in denen die Werte T_{KN} und T_{Kmax} in Nm gelistet sind und vergleichen Sie diese mit dem Wert T_{NK} für Ihre Anwendung. Stellen Sie sicher, dass die Werte des Zahnkranzes größer als die Anwendungswerte sind.

$$T_{KN} \ \& \ T_{Kmax} > T_{NK}$$

Schritt 6: Nachdem die Größe unter Verwendung der Drehmomentwerte ausgewählt ist, stellen Sie mit Hilfe der Tabelle auf Seite 9 sicher, dass der erforderliche Bohrungsdurchmesser in die Kupplung passt.

Schritt 7: Überprüfen Sie sorgfältig das Gesamtmaß der Kupplung, um zu gewährleisten, dass die Kupplung in den Einbauraum passt.

Step 1: Determine the nominal torque of your application:

$$T_N \text{ [Nm]} = \frac{P \text{ [kW]} \times 9550}{U \text{ /min [1/min]}}$$

Step 2: Calculate your application service factor using the charts on page 7.
The total service factor (K) will be:

$$K = K1 \times K2 \times K3$$

Step 3: Calculate the design torque (T_{NK}) of your application:
Design torque (T_{NK}) = nominal torque (T_N) x service factor (K).

Step 4: Using the Elastomer performance data charts on page 11, select the urethane shore hardness which best corresponds to your relative damping needs in the application.

Step 5: Next find the columns listing T_{KN} and T_{Kmax} values listed in Nm and compare them against the T_{NK} figure for your application. Make sure that the spider/coupling size values are larger than the application values.

$$T_{KN} \ \& \ T_{Kmax} > T_{NK}$$

Step 6: Once the size has been selected using the torque values, check the table on page 9 to make sure the bore size needed will fit in the coupling.

Step 7: Double check the overall dimensions of the coupling to ensure that it will fit in the space allowed for the coupling in the application.

Bei dem vorliegenden Auswahlprozess handelt es sich um ein vereinfachtes Verfahren zur Größenbestimmung unserer SPIDEX® Kupplung. Für eine genauere Auswahl ist die DIN 704 T2 anzuwenden. Die Welle-Nabe-Verbindung ist kundenseitig zu prüfen.

This process is a simplified procedure for determining the correct size when selecting one of our SPIDEX® couplings. Use DIN 704 T2 when making a precise selection. The shaft-hub connection has to be checked by the customer.

Definition der Begriffe Definition of terms

T_N [Nm]	Nenndrehmoment der Anwendung <i>Nominal torque of the application</i>
T_{Kmax} [Nm]	Maximales Drehmoment der Kupplung <i>Maximum torque of the coupling</i>
P [kW]	Leistung in Kilowatt <i>Power in kilowatts</i>
U/min [1/min]	Umdrehungen pro Minute <i>Revolutions per minute</i>
Nm	Newtonmeter <i>Newton meters</i>
T_{NK} [Nm]	Konstruktives Drehmoment der Anwendung <i>Constructional torque of the application</i>
T_{KW} [Nm]	Wechseldrehmoment <i>Alternating torque</i>
K	Betriebsfaktor <i>Application service factor</i>

Anwendungs-Betriebsfaktoren

Application service factors

K1

	Betriebsfaktor K1 Application service factor K1
<p>Gleichmäßiger Betrieb mit kleinen Beschleunigungsmassen. Hydraulik- und Zentrifugalpumpen, kleine Generatoren, Gebläse, Lüfter, Ventilatoren, Band/Schraubenförderer. <i>Uniform operation with small masses to be accelerated. Hydraulic and centrifugal pumps, light generators, blowers, fans, ventilators, belt/screw conveyors.</i></p>	1.0
<p>Gleichmäßiger Betrieb mit mittleren Beschleunigungsmassen. Blechbiegemaschinen, Holzbearbeitungsmaschinen, Walzwerke, Textilmaschinen, Mischer. <i>Uniform operation with medium masses to be accelerated. Sheet metal bending machines, wood working machines, mills, textile machines, mixers.</i></p>	1.2
<p>Ungleichmäßiger Betrieb mit mittleren Beschleunigungsmassen. Rotierende Öfen, Druckpressen, Generatoren, Schredder, Wickelmaschinen, Spinnmaschinen, Pumpen für dickflüssige Fluide. <i>Irregular operation with medium masses to be accelerated. Rotating ovens, printing presses, generators, shredders, winders, spinning machines, pumps for viscous fluids.</i></p>	1.3
<p>Ungleichmäßiger Betrieb und Stoßbelastungen mit mittleren Beschleunigungsmassen. Betonmischer, Fallhämmer, Seilbahnen, Papiermühlen, Kompressionspumpen, Propellerpumpen, Seilwinden, Zentrifugen. <i>Irregular operation and shocks, with medium masses to be accelerated. Concrete mixers, drop hammers, cable cars, paper mills, compression pumps, propeller pumps, rope winders, centrifuges.</i></p>	1.4
<p>Ungleichmäßiger Betrieb und starke Stoßbelastungen mit großen Beschleunigungsmassen. Bagger, Hammermühlen, Kolbenpumpen, Pressen, Erdbohrmaschinen, Scheren, Schmiedepressen, Steinbrecher. <i>Irregular operation and heavy shocks, with large masses to be accelerated. Excavators, hammer mills, piston pumps, presses, rotary boring machines, shears, forge presses, stone crushers.</i></p>	1.6
<p>Ungleichmäßiger Betrieb und sehr starke Stoßbelastungen mit sehr großen Beschleunigungsmassen. Kolbenkompressoren und Pumpen ohne Drehzahlregelung, schwere Walzensätze, Schweißmaschinen, Ziegelpressen, Steinbrecher. <i>Irregular operation and very heavy shocks, with very large masses to be accelerated. Piston-type compressors and pumps without speed variations, heavy roller sets, welding machines, brick presses, stone crushers.</i></p>	1.8

K2 – für Anläufe pro Stunde

K2 – for starts per hour

Anläufe pro Stunde Starts per hour	100	200	400	800
Betriebsfaktor K2 Service factor K2	1.0	1.2	1.4	1.6

K3 – für Umgebungstemperaturen

K3 – for ambient temperature

Zahnkranz Typ Insert type	-50 °C	-30 °C bis/up to +30 °C	+40 °C	+50 °C	+60 °C	+70 °C	+80 °C	+90 °C	+100 °C	+110 °C	+120 °C bis/up to +150 °C
Standard	–	1.0	1.2	1.3	1.4	1.55	1.8	2.2	–	–	–
TPS	1.0	1.0	1.1	1.2	1.3	1.45	1.6	1.8	2.1	2.5	3.2

SPIDEX®-Kupplungen für IEC-Normmotoren, Zahnkranz 92° Shore A

SPIDEX® couplings for IEC-standard motors, spider 92° Shore A

Motorbau- größe Motor size	Welle Shaft D x l [mm]		n = 750 [1/min] Leistung P Power P		Kupp- lungs- größe Size of coupling	T _K max [Nm]	n = 1000 [1/min] Leistung P Power P		Kupp- lungs- größe Size of coupling	T _K max [Nm]	n = 1500 [1/min] Leistung P Power P		Kupp- lungs- größe Size of coupling	T _K max [Nm]	n = 3000 [1/min] Leistung P Power P		Kupp- lungs- größe Size of coupling	T _K max [Nm]		
	= 1500 [1/min]	= 3000 [1/min]	[kW]	T _{AN} [Nm]			[kW]	T _{AN} [Nm]			[kW]	T _{AN} [Nm]			[kW]	T _{AN} [Nm]				
56	9 x 20		-	-	14/16	15	0.037	0.43	14/16	15	0.06	0.4	14/16	15	0.09	0.3	14/16	15		
					15		0.045	0.52	15		0.09	0.6	15		0.12	0.4	15			
63	11 x 23		-	-	15	15	0.060	0.70	15	15	0.12	0.9	15	15	0.18	0.6	15	15		
							0.090	1.10			0.18	1.2			0.25	0.9				
71	14 x 30		0.09	1.4	15	15	0.180	2.00	15	15	0.25	1.8	15	15	0.37	1.3	15	15		
			0.12	1.8			0.250	2.80			0.37	2.5			0.55	1.9				
80	19 x 40		0.18	2.5	19/24	20	0.370	3.70	19/24	20	0.55	3.7	19/24	20	0.75	2.5	19/24	20		
			0.25	3.5			0.550	5.50			0.75	5.0			1.10	3.7				
90 S	24 x 50		0.37	5.3	19/24	20	0.750	7.90	19/24	20	1.10	7.5	19/24	20	1.50	4.9	19/24	20		
90 L			0.55	7.9			1.100	11.00			1.50	10.0			2.20	7.4				
100 L	28 x 60		0.75	11.0	24/32	70	1.500	15.00	24/32	70	2.20	15.0	24/32	70	3.00	9.8	24/32	70		
			1.10	16.0			3.00	20.0			4.00	13.0								
112 M	28 x 60		1.50	21.0	24/32	70	2.200	22.00	24/32		4.00	27.0	24/32	70	4.00	13.0	24/32	70		
132 S	38 x 80		2.20	29.0	28/38	190	3.000	30.00	28/38	190	5.50	36.0	28/38	190	5.50	18.0	28/38	190		
							4.000	39.00			7.50	25.0								
132 M			3.00	40.0			5.500	55.00			7.50	49.0			7.50	25.0				
160 M	42 x 110		4.00	54.0	38/45	380	7.500	74.00	38/45	380	11.00	72.0	38/45	380	11.00	35.0	38/45	380		
			5.50	74.0			11.000	108.00			15.00	98.0			15.00	60.0				
160 L			7.50	100.0											18.50	60.0				
180 M	48 x 110		-	-	42/55	530	-	-	42/55	530	18.50	121.0	42/55	530	22.00	72.0	42/55	530		
180 L			11.00	147.0			15.000	147.00			22.00	144.0								
200 L	55 x 110		15.00	196.0	42/55	530	18.500	185.00	42/55	530	30.00	195.0	42/55	530	30.00	97.0	42/55	530		
							22.000	215.00			30.00	195.0			37.00	117.0				
225 S	60 x 140	55 x 110	18.50	245.0	48/60	620	-	-	48/60	620	37.00	245.0	48/60	620	37.00	117.0	42/55	530		
225 M			22.00	294.0			30.000	292.00			45.00	294.0			45.00	146.0				
250 M	65 x 140	60 x 140	30.00	390.0	65/75	1250	37.000	361.00	55/70	820	55.00	357.0	55/70	820	55.00	176.0	48/60	620		
280 S	75 x 140	65 x 140	37.00	490.0	65/75	1250	45.000	440.00	65/75	1250	75.00	487.0	65/75	1250	75.00	245.0	55/70	820		
280 M			45.00	585.0			55.000	536.00			90.00	584.0			90.00	294.0				
315 S	80 x 170	65 x 140	55.00	715.0	75/90	2560	75.000	730.00	75/90	2560	110.00	714.0	75/90	2560	110.00	350.0	55/70	820		
315 M			75.00	970.0			90.000	876.00			132.00	857.0			132.00	420.0				
315 L			90.00	1170.0	90/100	4800	110.000	1070.00	90/100	4800	160.00	1030.0	90/100	4800	160.00	513.0	65/75	1250		
	110.00	1420.0			132.000	1280.00			200.00	1290.0			200.00	641.0						
355 L	95 x 170	75 x 140	132.00	1710.0	90/100	4800	160.000	1550.00	90/100	4800	250.00	1610.0	90/100	4800	250.00	801.0	75/90	2560		
			160.00	2070.0			200.000	1930.00							315.00	2020.0			315.00	1010.0
			200.00	2580.0	100/110	6600	250.000	2420.00												
400 L	100 x 210	80 x 170	250.00	3230.0	110/125	9600	315.000	3040.00	100/110	6600	355.00	2280.0	100/110	6600	355.00	1140.0	90/100	4800		
									400.00	2560.0			400.00	1280.0						

Die Kupplungsvorauswahl erfolgte für den Normalbetrieb ohne Berücksichtigung von Betriebsfaktoren.
Coupling selection made for normal operation. For other conditions please notify the safety factors.

Abmessungen SPIDEX®-Kupplungen Dimensions SPIDEX® couplings

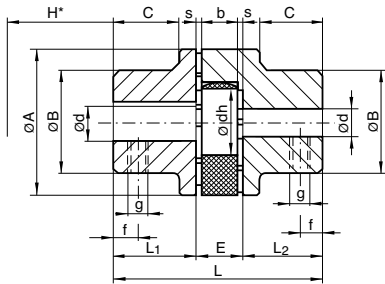

Nabenkombination A/A
Hub combination A/A

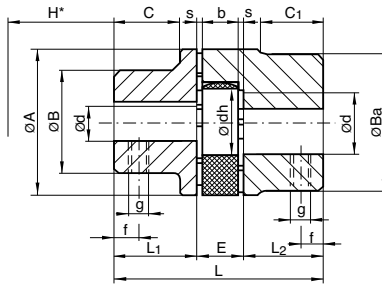

Nabenkombination A/B
Hub combination A/B

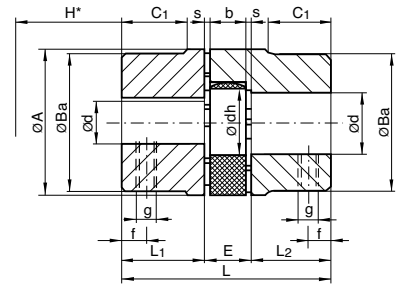

Nabenkombination B/B
Hub combination B/B

SPIDEX®	Bohrungen Bores				Abmessungen [mm] Dimensions [mm]														Gewicht Weight [kg]	Naben Sonderlänge Special hub length [mm]
	Fertigbohrung Finish bore				A	B	Ba	L	L1/L2	E	s	b	C	C1	dh	g	f	H*		
	Nabe A Hub A		Nabe B Hub B																	
min	max	min	max																	
Werkstoff: Aluminium Druckguss (ALU) Material: die-cast aluminium (ALU)																				
A15	-	-	4	15	26	-	26	28	10	8	1.0	6	-	-	12	M5	5	8	0.025	-
A19/24	6	19	19	24	40	32	39	66	25	16	2.0	12	20	21	18	M5	10	14	0.130	55
A24/32	8	24	16	32	55	40	53	78	30	18	2.0	14	24	26	27	M5	10	16	0.260	60
A28/38	10	28	28	38	65	48	63	90	35	20	2.5	15	28	29	30	M6	15	18	0.460	60
A38/45	14	38	38	45	80	66	79	114	45	24	3.0	18	37	39	38	M8	15	19	0.900	70
Werkstoff: Grauguss (GG), Sphäroguss (GGG), Stahl (St), Sinterstahl (Si) Material: cast iron (GG), SG iron (GGG), steel (St), sintered steel (Si)																				
A14/16 St	-	-	4	16	30	-	30	35	11	13	1.5	10	-	-	10	M4	5	12	0.140	18.5
A19/24 GG/St/Si	6	19	12	24	40	32	39	66	25	16	2.0	12	20	21	18	M5	10	14	0.350	55
A24/32 GG/St/Si	10	24	14	32	55	40	52	78	30	18	2.0	14	24	26	27	M5	10	16	1.000	60
A28/38 GG/St/Si	12	28	28	38	65	48	62	90	35	20	2.5	15	28	29	30	M6	15	18	1.600	80
A38/45 GG/GGG/St/Si	14	38	38	45	80	66	77	114	45	24	3.0	18	37	37	38	M8	15	19	2.300	110
A42/55 GG/GGG/St/Si	19	42	42	55	95	75	94	126	50	26	3.0	20	40	40	46	M8	20	21	3.600	110
A48/60 GG/GGG/St/Si	19	48	48	60	105	85	102	140	56	28	3.5	21	45	45	51	M8	20	22	4.800	110
A55/70 GG/GGG/St	19	55	55	70	120	98	118	160	65	30	4.0	22	52	52	60	M10	20	23	7.400	140
A65/75 GG/GGG/St	22	65	65	75	135	115	132	185	75	35	4.5	26	61	59	68	M10	20	27	10.900	140
A75/90 GG/GGG/St	30	75	75	90	160	135	158	210	85	40	5.0	30	69	65	80	M10	25	31	17.700	195
A90/100 GG/GGG/St	40	90	90	100	200	160	180	245	100	45	5.5	34	81	81	100	M10	25	35	29.500	140/210
A100/110 GG/GGG/St	-	-	55	110	225	-	200	270	110	50	6.0	38	-	89	113	M16	30	39	43.500	-
A110/125 GG/GGG/St	-	-	65	125	255	-	230	295	120	55	6.5	42	-	96	127	M16	35	43	63.000	-
A125/145 GG/GGG/St	-	-	65	145	290	-	265	340	140	60	7.0	46	-	112	147	M16	40	47	95.000	-

H* ist das Mindestmaß, um welches die Aggregate auseinander geschoben werden müssen, um einen radialen Ausbau zu ermöglichen. Fertigbohrung nach ISO-Passung H7, Passfedernut nach DIN 6885, Blatt 1 (JS9). Das Gewicht und Massenträgheitsmoment beziehen sich auf die Werkstoffe Al/GG/GGG bei max. möglichem Durchmesser d ohne Nut.
H* is the minimum dimension required for the disassembly of the aggregates in the radial direction. Finish bore acc. to ISO standard H7, keyway acc. to DIN 6885, sheet 1 (JS9).
Weight and moment of inertia in relation to the materials Al/GG/GGG with max. diameter without keyway.

Standardprogramm

- A Naben und B Naben in Aluminium Druckguss „ALU“ und Grauguss „GG“
- B Naben in Sphäroguss „GGG“, Stahl „St“, Sinterstahl „Si“
- Sonderanfertigungen lieferbar
- Baureihen 140/160/180 auf Anfrage

Standard program

- A hubs and B hubs made of die-cast aluminium “ALU” and cast iron “GG”
- B hubs made of SG iron “GGG”, steel “St”, sintered steel “Si”
- Custom-made versions available
- Series 140/160/180 on request

Massenträgheitsmomente J [kg m²] (Standardnabe mit maximalem Bohrungsdurchmesser ohne Nut) Moment of inertia J [kg m²] (Standard hub with max. diameter of bore without keyway)

Nabenteil Part of coupling	Material Material	Kupplungsgröße Coupling size														
		14/16	15	19/24	24/32	28/38	38/45	42/55	48/60	55/70	65/75	75/90	90/100	100/110	110/125	125/145
Nabe A Hub A	Al	-	-	0.000010	0.000040	0.000100	0.000350	-	-	-	-	-	-	-	-	
	GG/GGG/St	-	-	0.000050	0.000250	0.000400	0.001000	0.002000	0.003000	0.006000	0.012500	0.025000	0.069000	-	-	
Nabe B Hub B	Al	-	0.000004	0.000020	0.000090	0.000200	0.000450	-	-	-	-	-	-	-		
	GG/GGG/St	0.000020	-	0.000050	0.000200	0.000700	0.001000	0.003000	0.005000	0.010000	0.018300	0.041000	0.090000	0.154000	0.091000	0.575000
Zahnkranz Spider	PU	-	-	0.000003	0.000010	0.000020	0.000050	0.000100	0.000200	0.000300	0.000500	0.002000	0.004000	0.007000	0.015000	0.025000

Abmessungen SPIDEX®-Flanschcupplungen

Dimensions SPIDEX® flange couplings

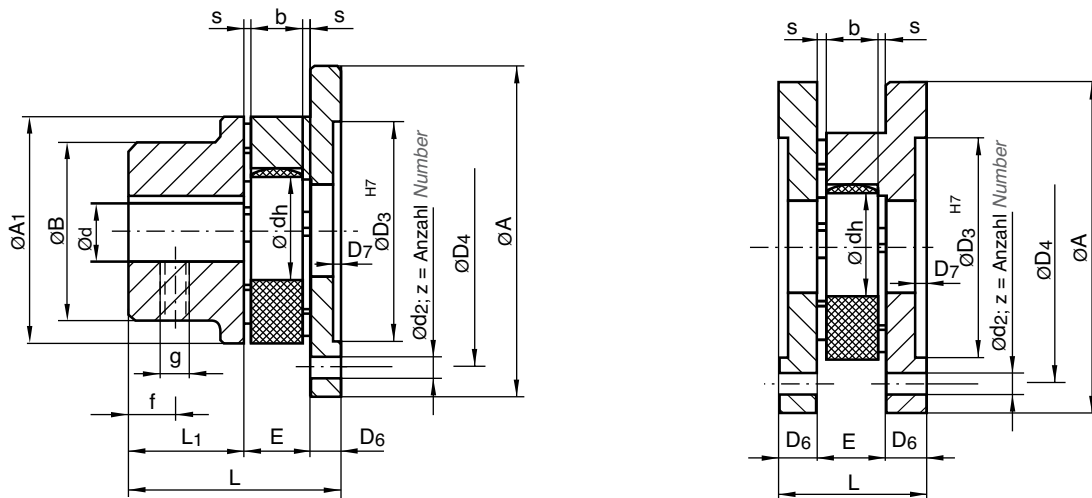

Baureihe F

Series F

SPIDEX®	Fertigbohrung ¹⁾ Finish bore ¹⁾		Abmessungen [mm] Dimensions [mm]														Gewicht Weight [kg]	Massen- trägheits- moment ²⁾ Moment of inertia ²⁾ J [kg m ²]			
	min	max ⁴⁾	A	A1	B	L1	L	E	s	b	dh	g	f	D6	D7	d2 DIN 69			z Anzahl Number	D3	D4
F 28	10	28	100	65	65	35	65	20	2.5	15	30	M8	15	10	1.5	7	6	65	80	1.18	0.0012
F 38	14	38	115	80	66	45	79	24	3.0	18	38	M8	15	10	1.5	7	6	80	95	1.87	0.0023
F 42	19	42	140	95	75	50	88	26	3.0	20	46	M8	20	12	2.0	9	6	95	115	3.06	0.0054
F 48	19	48	150	105	85	56	96	28	3.5	21	51	M8	20	12	2.0	9	8	105	125	3.88	0.0080
F 55	19	55	175	120	98	65	111	30	4.0	22	60	M10	20	16	2.0	11	8	120	145	6.21	0.0178
F 65	22	65	190	135	115	75	126	35	4.5	26	68	M10	20	16	2.0	11	10	135	160	8.63	0.0293
F 75	30	75	215	160	135	85	144	40	5.0	30	80	M10	25	19	2.5	14	10	160	185	13.20	0.0595
F 90	40	90	260	200	160	100	165	45	5.5	34	100	M12	30	20	3.0	14	12	200	225	22.00	0.1443

Baureihe FF

Series FF

SPIDEX®	Abmessungen [mm] Dimensions [mm]												Gewicht Weight [kg]	Massenträgheits- moment ²⁾ Moment of inertia ²⁾ J [kg m ²]
	A	L	E	s	b	dh	D6	D7	d2 DIN 69 ³⁾	z Anzahl Number	D3	D4		
FF 28	100	40	20	2.5	15	30	10	1.5	7	6	65	80	1.19	0.0015
FF 38	115	44	24	3.0	18	38	10	1.5	7	6	80	95	1.66	0.0028
FF 42	140	50	26	3.0	20	46	12	2.0	9	6	95	115	2.91	0.0072
FF 48	150	52	28	3.5	21	51	12	2.0	9	8	105	125	3.35	0.0092
FF 55	175	62	30	4.0	22	60	16	2.0	11	8	120	145	5.78	0.0230
FF 65	190	67	35	4.5	26	68	16	2.0	11	10	135	160	7.13	0.0340
FF 75	215	78	40	5.0	30	80	19	2.5	14	10	160	185	10.50	0.0650
FF 90	260	85	45	5.5	34	100	20	3.0	14	12	200	225	16.50	0.1500

1) Fertigbohrung nach ISO-Passung H7, Passfedernut nach DIN 6885, Blatt 1 (J59).

2) Gewicht und Massenträgheitsmoment für Werkstoffe GG/GGG bei maximalem Bohrungsdurchmesser ohne Nut.

3) Wenn Gewindebohrungen anstatt Durchgangsbohrungen benötigt werden, ändert sich die Flanschbezeichnung in BF bzw. BFF.

4) Wenn größere Fertigbohrungen benötigt werden, können B-Naben verwendet werden.

1) Finish bore acc. to ISO standard H7, keyway acc. to DIN 6885, sheet 1 (J59).

2) Weight and moment of inertia in relation to the materials GG/GGG with max. diameter without keyway.

3) If threaded bores are required instead of through bores, flange designation is changed to "BF" or "BFF".

4) If larger bore diameters are required, hub type B may be used.

Standard-Zahnkränze Standard spiders



Zahnkranz Polyurethan 92° Shore A Spider polyurethane 92° Shore A

- Weiß
White
- Allgemeine Antriebe
Normal drives



Zahnkranz Polyurethan 95/98° Shore A Spider polyurethane 95/98° Shore A

- Rot
Red
- Allgemeine Antriebe mit erhöhten Belastungen
Normal drives with high performance



Zahnkranz Polyurethan 64° Shore D Spider polyurethane 64° Shore D

- Grün
Green
- Hohe Belastbarkeit mit geringem Verdrehwinkel
High performance with small torsional angle

Technische Daten Technical data

Zahnkranz Spider	Größe Size	Drehmoment Torque [Nm]			Max. Drehzahl Max. RPM n [1/min]		Verdrehwinkel Torsional angle		Drehfedersteife Torsional rigidity C _{dyn} [Nm/rad]				Verhältnis- mäßige Dämpfung Relative damping
		Nenn Contin T _{KN}	Maximal Maximum T _{Kmax}	Wechsel Alternat. T _{KW}	V*	30 m/s	40 m/s	T _{KN} Φ _{KN}	T _{Kmax} Φ _{Kmax}	1.00 T _{KN}	0.75 T _{KN}	0.5 T _{KN}	
92° Shore Skala A Farbe: Weiß Scale A Colour: White	14/16, 15	7.5	15	2.0	19000	–	6.4°	10°	0.38 x 10 ³	0.31 x 10 ³	0.24 x 10 ³	0.14 x 10 ³	0.75
	19/24	10.0	20	2.6	14000	19000			1.28 x 10 ³	1.05 x 10 ³	0.80 x 10 ³	0.47 x 10 ³	
	24/32	35.0	70	9.1	10600	14000	4.86 x 10 ³	3.98 x 10 ³	3.01 x 10 ³	1.79 x 10 ³			
	28/38	95.0	190	25.0	8500	11800	10.90 x 10 ³	8.94 x 10 ³	6.76 x 10 ³	4.01 x 10 ³			
	38/45	190.0	380	49.0	7100	9500	21.05 x 10 ³	17.26 x 10 ³	13.05 x 10 ³	7.74 x 10 ³			
	42/55	265.0	530	69.0	6000	8000	23.74 x 10 ³	19.47 x 10 ³	14.72 x 10 ³	8.73 x 10 ³			
	48/60	310.0	620	81.0	5600	7100	36.70 x 10 ³	30.09 x 10 ³	22.75 x 10 ³	13.49 x 10 ³			
	55/70	410.0	820	107.0	4750	6300	50.72 x 10 ³	41.59 x 10 ³	31.45 x 10 ³	18.64 x 10 ³			
	65/75	625.0	1250	163.0	4250	5600	97.13 x 10 ³	79.65 x 10 ³	60.22 x 10 ³	35.70 x 10 ³			
	75/90	1280.0	2560	333.0	3550	4750	113.32 x 10 ³	92.92 x 10 ³	70.26 x 10 ³	41.65 x 10 ³			
	90/100	2400.0	4800	624.0	2800	3750	190.09 x 10 ³	155.87 x 10 ³	117.86 x 10 ³	69.86 x 10 ³			
	100/110	3300.0	6600	858.0	2500	3350	253.08 x 10 ³	207.53 x 10 ³	156.91 x 10 ³	93.01 x 10 ³			
	110/125	4800.0	9600	1248.0	2240	3000	311.61 x 10 ³	255.52 x 10 ³	193.20 x 10 ³	114.52 x 10 ³			
125/145	6650.0	13300	1729.0	2000	2650	474.86 x 10 ³	389.39 x 10 ³	294.41 x 10 ³	174.51 x 10 ³				
98° Shore Skala A Farbe: Rot Scale A Colour: Red	14/16, 15	12.5	25	3.3	19000	–	3.2°	5°	0.56 x 10 ³	0.46 x 10 ³	0.35 x 10 ³	0.21 x 10 ³	0.70
	19/24	17.0	34	4.4	14000	19000	6.4°	10°	2.92 x 10 ³	2.39 x 10 ³	1.81 x 10 ³	1.07 x 10 ³	
	24/32	60.0	120	16.0	10600	14000	9.93 x 10 ³	8.14 x 10 ³	6.16 x 10 ³	3.65 x 10 ³			
	28/38	160.0	320	42.0	8500	11800	26.77 x 10 ³	21.95 x 10 ³	16.60 x 10 ³	9.84 x 10 ³			
	38/45	325.0	650	85.0	7100	9500	48.57 x 10 ³	39.83 x 10 ³	30.11 x 10 ³	17.85 x 10 ³			
	42/55	450.0	900	117.0	6000	8000	54.50 x 10 ³	44.69 x 10 ³	33.79 x 10 ³	20.03 x 10 ³			
	48/60	525.0	1050	137.0	5600	7100	65.29 x 10 ³	53.54 x 10 ³	40.48 x 10 ³	24.00 x 10 ³			
	55/70	685.0	1370	178.0	4750	6300	94.97 x 10 ³	77.88 x 10 ³	58.88 x 10 ³	34.90 x 10 ³			
95° Shore Skala A Farbe: Rot Scale A Colour: Red	65/75	940.0	1880	244.0	4250	5600	3.2°	5°	129.51 x 10 ³	106.20 x 10 ³	80.30 x 10 ³	47.60 x 10 ³	0.60
	75/90	1920.0	3840	499.0	3550	4750			197.50 x 10 ³	161.95 x 10 ³	122.45 x 10 ³	72.58 x 10 ³	
	90/100	3600.0	7200	936.0	2800	3750			312.20 x 10 ³	256.00 x 10 ³	193.56 x 10 ³	114.73 x 10 ³	
	100/110	4950.0	9900	1287.0	2500	3350			383.26 x 10 ³	314.27 x 10 ³	237.62 x 10 ³	140.85 x 10 ³	
	100/125	7200.0	14400	1872.0	2240	3000			690.06 x 10 ³	565.85 x 10 ³	427.84 x 10 ³	253.60 x 10 ³	
	125/145	10000.0	20000	2600.0	2000	2650			1343.64 x 10 ³	1101.79 x 10 ³	833.06 x 10 ³	493.79 x 10 ³	
64° Shore** Skala D Farbe: Grün Scale D Colour: Green	24/32	75.0	150	19.5	10600	14000	2.5°	3.6°	15.11 x 10 ³	12.39 x 10 ³	9.37 x 10 ³	5.55 x 10 ³	0.60
	28/38	200.0	400	52.0	8500	11800			27.52 x 10 ³	22.57 x 10 ³	17.06 x 10 ³	10.12 x 10 ³	
	38/45	405.0	810	105.0	7100	9500			70.15 x 10 ³	57.52 x 10 ³	43.49 x 10 ³	25.78 x 10 ³	
	42/55	560.0	1120	146.0	6000	8000			79.86 x 10 ³	65.49 x 10 ³	49.52 x 10 ³	29.35 x 10 ³	
	48/60	655.0	1310	170.0	5600	7100			95.51 x 10 ³	78.32 x 10 ³	59.22 x 10 ³	35.10 x 10 ³	
	55/70	825.0	1650	215.0	4750	6300			107.52 x 10 ³	88.50 x 10 ³	66.91 x 10 ³	39.66 x 10 ³	
	65/75	1175.0	2350	306.0	4250	5600			151.09 x 10 ³	123.90 x 10 ³	93.68 x 10 ³	55.53 x 10 ³	
	75/90	2400.0	4800	624.0	3550	4750			248.22 x 10 ³	203.54 x 10 ³	153.90 x 10 ³	91.22 x 10 ³	
	90/100	4500.0	9000	1170.0	2800	3750			674.52 x 10 ³	553.11 x 10 ³	418.20 x 10 ³	247.89 x 10 ³	

* Bei Umfangsgeschwindigkeit über V = 30 m/s ist dynamisches Wuchten erforderlich. ** In Verbindung mit GG-Naben bitte Rücksprache
* For speeds of over V = 30 m/s dynamic balancing is necessary. ** Please contact us if spider is to be used in combination with cast-iron (GG) hubs

TPS-Zahnkränze für den Einsatz bei hohen Temperaturen TPS spiders for high-temperature usage



TPS-Zahnkranz
Polyurethan optimiert
92° Shore A
TPS Spider
high-performance
polyurethane
92° Shore A

■ Gelb
Yellow

TPS-Zahnkranz
Polyurethan optimiert
98° Shore A
TPS Spider
high-performance
polyurethane
98° Shore A

■ Weinrot
Wine Red

- Jetzt bis +150 °C Einsatztemperatur
- Hergestellt aus Hochleistungs-PU-Kunststoff
- Für SPIDEX®-Kupplungsgrößen von 19 – 90
- Now for operating temperatures up to +150 °C
- Made from high-performance polyurethane
- For SPIDEX® couplings sizes 19 – 90

Technische Daten Technical data

Zahnkranz Spider	Größe Size	Drehmoment Torque [Nm]			Max. Drehzahl Max. rotation n [1/min]		Verdrehwinkel Torsional angle		Drehfedersteife Torsional rigidity C _{dyn} [Nm/rad]				Verhältnismäßige Dämpfung Relative damping
		Nenn Contin. T _{KN}	Maximal T _{Kmax}	Wechsel Alternat. T _{KW}	V*	40 m/s	T _{KN} Φ _{KN}	T _{Kmax} Φ _{Kmax}	1.00 T _{KN}	0.75 T _{KN}	0.5 T _{KN}	0.25 T _{KN}	
92° Shore Skala A Farbe: Gelb Scale A Colour: Yellow	19/24	10	20	2.6	14000	19000	3.2°	5°	1.28 x 10 ³	1.05 x 10 ³	0.80 x 10 ³	0.47 x 10 ³	0.75
	24/32	35	70	9.1	10600	14000			4.86 x 10 ³	3.98 x 10 ³	3.01 x 10 ³	1.79 x 10 ³	
	28/38	95	190	25.0	8500	11800			10.90 x 10 ³	8.94 x 10 ³	6.76 x 10 ³	4.01 x 10 ³	
	38/45	190	380	49.0	7100	9500			21.05 x 10 ³	17.26 x 10 ³	13.05 x 10 ³	7.74 x 10 ³	
	42/55	265	530	69.0	6000	8000			23.74 x 10 ³	19.47 x 10 ³	14.72 x 10 ³	8.73 x 10 ³	
	48/60	310	620	81.0	5600	7100			36.70 x 10 ³	30.09 x 10 ³	22.75 x 10 ³	13.49 x 10 ³	
	55/70	410	820	107.0	4750	6300			50.72 x 10 ³	41.59 x 10 ³	31.45 x 10 ³	18.64 x 10 ³	
	65/75	625	1250	163.0	4250	5600			97.13 x 10 ³	79.65 x 10 ³	60.22 x 10 ³	35.70 x 10 ³	
	75/90	1280	2560	333.0	3550	4750			113.32 x 10 ³	92.92 x 10 ³	70.26 x 10 ³	41.65 x 10 ³	
	90/100	2400	4800	624.0	2800	3750			190.09 x 10 ³	155.87 x 10 ³	117.86 x 10 ³	69.86 x 10 ³	
98° Shore Skala A Farbe: Weinrot Scale A Colour: Wine Red	19/24	17	34	4.4	14000	19000	3.2°	5°	2.92 x 10 ³	2.39 x 10 ³	1.81 x 10 ³	1.07 x 10 ³	0.70
	24/32	60	120	16.0	10600	14000			9.93 x 10 ³	8.14 x 10 ³	6.16 x 10 ³	3.65 x 10 ³	
	28/38	160	320	42.0	8500	11800			26.77 x 10 ³	21.95 x 10 ³	16.60 x 10 ³	9.84 x 10 ³	
	38/45	325	650	85.0	7100	9500			48.57 x 10 ³	39.83 x 10 ³	30.11 x 10 ³	17.85 x 10 ³	
	42/55	450	900	117.0	6000	8000			54.50 x 10 ³	44.69 x 10 ³	33.79 x 10 ³	20.03 x 10 ³	
	48/60	525	1050	137.0	5600	7100			65.29 x 10 ³	53.54 x 10 ³	40.48 x 10 ³	24.00 x 10 ³	
	55/70	685	1370	178.0	4750	6300			94.97 x 10 ³	77.88 x 10 ³	58.88 x 10 ³	34.90 x 10 ³	
95° Shore Skala A, Farbe: Rot Scale A, Colour: Red	65/75	940	1880	244.0	4250	5600	3.2°	5°	129.51 x 10 ³	106.20 x 10 ³	80.30 x 10 ³	47.60 x 10 ³	
	75/90	1920	3840	499.0	3550	4750			197.50 x 10 ³	161.95 x 10 ³	122.45 x 10 ³	72.58 x 10 ³	
	90/100	3600	7200	936.0	2800	3750			312.20 x 10 ³	256.00 x 10 ³	193.56 x 10 ³	114.73 x 10 ³	

* Bei Umfangsgeschwindigkeit über V = 30 m/s ist dynamisches Wuchten erforderlich.
* For speeds of over V = 30 m/s dynamic balancing is necessary.

* Für Umfangsgeschwindigkeit über V = 35 m/s nur Stahl bzw. Sphäroguss verwenden.
* For rotational speeds above V = 35 m/s, use only steel or SG iron.

Einsatzbedingungen für SPIDEX®-Zahnkränze (Standard und TPS) Operating conditions for SPIDEX® spiders (Standard and TPS)

	Standard	TPS	Standard	TPS	Standard
Zahnkranzhärte Hardness of spider	92° Shore A	92° Shore A	95°/98° Shore A	98° Shore A	64° Shore D
Zahnkranzfarbe Colour of spider	Weiß White	Gelb Yellow	Rot Red	Weinrot Wine Red	Grün Green
Zul. Temperaturbereich Dauereinsatz Permissible durable temperature range	-40 °C bis/up to +90 °C	-50 °C bis/up to +120 °C	-30 °C bis/up to +100 °C	-50 °C bis/up to +120 °C	-20 °C bis/up to +100 °C
Zul. kurzfristige Temperaturspitzen Permissible short-term temperature peaks	-50 °C bis/up to +120 °C	-50 °C bis/up to +150 °C	-40 °C bis/up to +120 °C	-50 °C bis/up to +150 °C	-30 °C bis/up to +120 °C
Dämpfung Damping	Gut Good	Gut Good	Mittel Medium	Mittel Medium	Gering Low
Elastizität Elasticity	Mittel Medium	Mittel Medium	Hart Hard	Hart Hard	Sehr hart Very hard
Abriebfestigkeit Abrasion resistance	Sehr gut Very good	Sehr gut Very good	Gut Good	Gut Good	Gut Good
Dauerfestigkeit Durability	Sehr gut Very good	Sehr gut Very good	Sehr gut Very good	Sehr gut Very good	Sehr gut Very good
Einsatzbereiche Typical applications	Allgemeine Antriebe Normal drives	Allgemeine Antriebe Normal drives	Allgemeine Antriebe mit erhöhten Belastungen Normal drives with high performance	Allgemeine Antriebe mit erhöhten Belastungen Normal drives with high performance	Hohe Belastbarkeit mit geringem Verdrehwinkel High performance with small torsional angle

Bestellbezeichnungen für SPIDEX® Order description for SPIDEX®

Typenbezeichnung Kupplungsnahe Model type of hub

KL		ST	A38/45 .		A35 x 31	L = 70		SO	
Standard <i>Standard</i>	-					Verlängerte Naben <i>Extended hub length</i>			
Klemmnabe <i>Clamping hub</i>	KL					-	Standard <i>Standard</i>		
						70	Siehe Seite 9 <i>See page 9</i>		
Nabenwerkstoff <i>Material of hub</i>			Nabengröße/Nabenausführung <i>Size/Design of hub</i>		Beispiel Fertigbohrung <i>Example finish bore</i>		Sonderbearbeitung <i>Special machining</i>		
Aluminium <i>Aluminium</i>	Al		A15	A14/16	Ung.	Ungebohrt <i>Unbored</i>		-	Standard <i>Standard</i>
Aluminium Druckguss <i>Die-cast aluminium</i>	ALU		A19	A19/24	Vorg.	Vorgebohrt <i>Prebored</i>		SO	Sonderzeichnung <i>Special drawing</i>
Sinterstahl <i>Sintered steel</i>	Si		A24	A24/32	38H7	Metrisch* <i>Metric*</i>			
Grauguss <i>Cast iron</i>	GG		A28	A28/38	B17	Kegelig** <i>Tapered**</i>			
Sphäroguss <i>SG iron</i>	GGG		A38	A38/45	F	Zöllig*** <i>Inch bored***</i>			
Stahl <i>Steel</i>	St		A42	A42/55	Profile	SAE	SAE 16/32Z13***		
			A48	A48/60		DIN 5482	A35x31***		
			A55	A55/70		DIN 5480	N30x2x14x9G***		
			A65	A65/75					
			A75	A75/90					
			A90	A90/100					
			A100	A100/110					
			A110	A110/125					
			A125	A125/145					

* Siehe Seite 14 *See page 14*** Siehe Seite 16 *See page 16**** Siehe Seite 15 *See page 15*

Typenbezeichnung Kupplungsflansch Model type of flange

GGG		A38 . FLANSCH	F
Flanschwerkstoff <i>Material of flange</i>		FLANGE	
Sphäroguss <i>SG iron</i>	GGG	A28	-
GGG40		A38	Ungebohrt <i>Unbored</i>
		A42	F
		A48	Durchgangslöcher <i>Through bores</i>
		A55	BF
		A65	Gewindebohrungen <i>Threaded bores</i>
		A75	CFA
		A90	Ausführung für Hydraulikpumpen
		A100	CFB
			Fabrikat LINDE <i>Designed for</i>
			hydraulic pumps
			CFD
			manufacturer LINDE

Basisprogramm Zollbohrungen

Standard inch bores

Typ Type	Nabe Hub	Material Material	V	TA	DNC	S	E	ES	ED	DNH	Ad	AS	A	G	F	B	Bs	H	Hs	Sb	Sd	Js	K	M	C	N	L	KS	NM	D	P	W	
A19	A	Al	x	x	x				x	x	x	x	x																				
A19/24	B													x		x																	
A19	A	GG	x	x				x	x	x			x																				
A19/24	B													x	x																		
A24	A	Al		x	x	x	x	x	x	x	x	x	x	x	x																		
A24/32	B															x	x		x	x				x									
A24	A	GG		x		x		x	x	x	x	x	x	x	x																		
A24/32	B																x			x			x	x									
A28	A	Al		x				x		x			x	x	x		x																
A28/38	B																					x	x	x	x	x							
A28	A	GG								x			x	x	x		x																
A28/38	B																					x	x	x	x	x							
A38	A	Al							x	x		x	x	x	x		x		x	x	x	x	x	x	x								
A38/45	B																																
A38	A	GG												x	x		x						x										
A38/45	B																																
A42	A	GG												x	x		x						x	x	x	x							
A42/55	B																																
A48	A	GG												x	x								x	x	x	x	x						
A48/60	B																																

Typ Type	Nabe Hub	Material Material	G	F	K	M	C	N	L	NM	DS	D	P	W	WN	WA	WK
A55	A	GG	x	x	x	x	x	x	x	x							
A55/70	B												x	x			
A65	A	GG			x	x	x	x	x			x		x			
A65/75	B														x		
A75	A	GG			x		x		x		x	x		x			
A75/90	B														x		
A90	A	GG							x		x	x					x

Abmessungen Zollbohrungen

Dimensions inch bores

Code	Ø d [mm]	b [mm]	t2 [mm]	Code	Ø d [mm]	b [mm]	t2 [mm]	Code	Ø d [mm]	b [mm]	t2 [mm]
		+0.05	+0.2			+0.05	+0.2			+0.05	+0.2
V	11.110 H7	3.18	12.34	G	22.22 +0.030	4.75	24.70	C	38.070 +0.030	9.55	43.0
TA	12.700 +0.030	3.17	14.30	F	22.22 +0.030	6.35	25.20	N	41.290 +0.030	9.55	46.1
DNC	13.450 H7	3.17	14.90	B	25.37 +0.030	4.78	27.80	L	44.450 +0.030	11.11	49.5
S	15.870 +0.030	3.97	17.90	BS	25.38 +0.030	6.37	28.30	NM	47.625 +0.030	12.73	53.4
E	15.870 +0.030	3.17	17.50	H	25.40 +0.030	4.78	27.80	DS	50.770 +0.030	12.73	56.4
ES	15.880 +0.030	4.00	17.70	SB	28.60 +0.020	6.35	32.10	D	50.800 +0.030	12.73	55.1
Ed	15.890 +0.020	4.75	18.30	SD	28.58 +0.030	7.93	32.10	P	53.950 +0.030	12.73	59.6
DNH	17.465 H7	4.75	19.60	JS	31.75 +0.030	6.35	34.62	W	60.370 +0.030	15.87	68.8
Ad	19.020 +0.030	3.17	20.70	K	31.75 K7	7.93	35.50	WN	73.025 +0.030	19.05	83.0
AS	19.020 +0.030	4.78	21.30	KS	31.75 +0.030	7.93	36.60	WA	85.780 +0.030	22.22	97.3
A	19.050 +0.030	4.78	21.30	M	34.94 +0.030	7.93	39.00	WK	92.080 +0.030	22.22	103.3

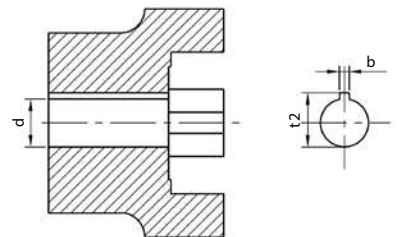

Verzahnungsvarianten

Available splines

Profil DIN 5480 Spline DIN 5480	Profil DIN 5482 Spline DIN 5482	Profil SAE Spline SAE
N 20 x 1.25 x 14 x 9H	A 17 x 14	16/32 x 9 J 498 B
N 25 x 1.25 x 18 x 9H	A 28 x 25	16/32 x 11 J 498 B
N 30 x 2 x 14 x 9H	A 30 x 27	16/32 x 13 J 498 B
N 35 x 2 x 16 x 9H	A 35 x 31	16/32 x 15 J 498 B
N 40 x 2 x 18 x 9H	A 40 x 36	16/32 x 21 J 498 B
N 45 x 2 x 21 x 9H	A 45 x 41	16/32 x 23 J 498 B
N 50 x 2 x 24 x 9G	A 48 x 44	16/32 x 27 J 498 B
N 55 x 2 x 26 x 9G	A 50 x 45	12/24 x 14 J 498 B
N 60 x 2 x 28 x 9G	A 58 x 53	12/24 x 17 J 498 B
N 70 x 3 x 22 x 9H	A 70 x 64	8/16 x 13 J 498 B
N 80 x 3 x 25 x 7H		13/4 x 6 J 498 B
N 90 x 3 x 28 x 9G		

Kupplungs-naben mit Verzahnung sind vorzugsweise als Klemmnabe einzusetzen!
Erhältlich jedoch auch ohne Klemmung mit Gewindestift.

Coupling hubs with spline are recommended as clamping hub!
Available also with set screw.

Maximal zulässige Verlagerungswerte für Zahnkranzhärten 92°, 95°, 98° Shore A Max. permissible displacement values for spiders 92°, 95°, 98° Shore A

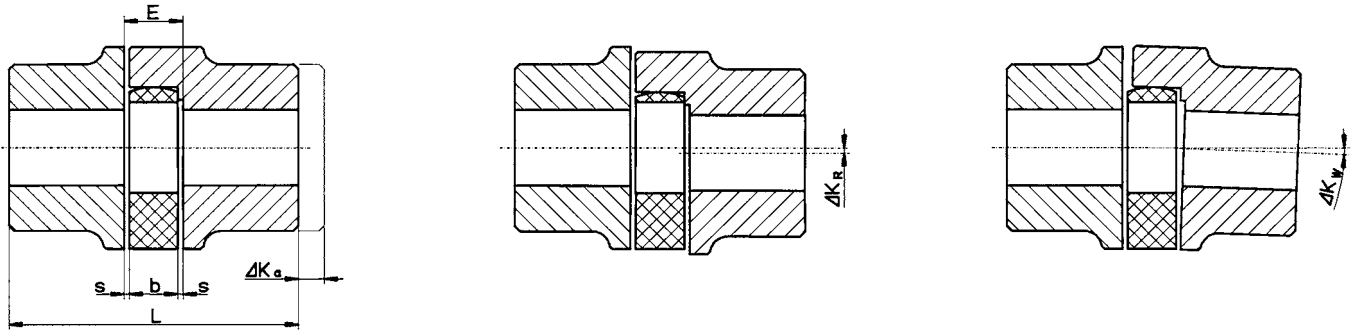

SPIDEX®	Abmessungen Dimensions [mm]				Axialversatz Axial displacement ΔKa [mm]	Radialversatz Radial displacement ΔKr [mm]				Winkelversatz Angular displacement ΔKw [°]			
	L	E	b	s		Drehzahl Rotation n [1/min]				Drehzahl Rotation n [1/min]			
						750	1000	1500	3000	750	1000	1500	3000
A14	35	13	10	1.5	1.0	0.22	0.20	0.16	0.11	1.3	1.3	1.2	1.1
A15	28	8	6	1.0	1.0	0.22	0.20	0.16	0.11	1.3	1.3	1.2	1.1
A19	66	16	12	2.0	1.2	0.27	0.24	0.20	0.13	1.3	1.3	1.2	1.1
A24	78	18	14	2.0	1.4	0.30	0.27	0.22	0.15	1.1	1.0	0.9	0.8
A28	90	20	15	2.5	1.5	0.34	0.30	0.25	0.17	1.1	1.0	0.9	0.8
A38	114	24	18	3.0	1.8	0.38	0.35	0.28	0.19	1.1	1.1	1.0	0.8
A42	126	26	20	3.0	2.0	0.43	0.38	0.32	0.21	1.1	1.1	1.0	0.8
A48	140	28	21	3.5	2.1	0.50	0.44	0.36	0.25	1.2	1.2	1.1	0.9
A55	160	30	22	4.0	2.2	0.54	0.46	0.38	0.26	1.2	1.2	1.1	1.0
A65	185	35	26	4.5	2.6	0.56	0.50	0.42	0.28	1.2	1.2	1.2	1.0
A75	210	40	30	5.0	3.0	0.65	0.58	0.48	0.32	1.3	1.2	1.2	1.0
A90	245	45	34	5.5	3.4	0.68	0.60	0.50	0.34	1.3	1.3	1.2	1.1
A100	270	50	38	6.0	3.8	0.71	0.64	0.52	0.36	1.3	1.3	1.2	1.1
A110	295	55	42	6.5	4.2	0.75	0.67	0.55	0.38	1.3	1.3	1.3	1.1
A125	340	60	46	7.0	4.6	0.80	0.70	0.60	-	1.3	1.3	1.3	-

- Das Längenmaß L vergrößert sich um die angegebenen ΔKa-Werte.
- Die aufgeführten Verlagerungswerte sind allgemeine Richtwerte.
- Bei gleichzeitigem Winkel- und Radialversatz können die angegebenen Werte nur anteilmäßig ausgenutzt werden.
- Die Tabellenwerte sind gültig für eine Betriebstemperatur T = +30 °C. Bei einer Temperaturerhöhung müssen die max. zulässigen Radial- und Winkelverlagerungswerte mit dem Temperaturfaktor St multipliziert werden.

- The dimension L increases by the given ΔKa values.
- The above mentioned displacement values are general guidelines.
- In case of angular and radial displacements, the values can only be used proportionately.
- The values are valid for an operating temperature of T = +30°C. If the temperature increases, the permissible radial and simultaneous angular displacement values must be multiplied by the temperature factor St.

Temperatur T Temperature T	-40 < +30 °C	+30 < +40 °C	+40 < +60 °C	+60 < +80 °C	+80 °C <
Faktor St Factor St	1.0	0.8	0.7	0.6	0.3

Sorgfältiges Ausrichten der Wellen erhöht die Lebensdauer der Kupplung
Achtung: Montageanleitung beachten

Careful alignment will extend the coupling life
Caution: observe the assembly instructions

Kegelige Bohrungen Taper bores

Code	Konus 1:8 Taper 1:8			
	Ø d	b	t2	l
...N/1	9.750	2.40	10.70	17.0
...N/1c	11.600	3.00	12.90	16.5
...N/1e	13.000	2.40	13.80	21.0
...N/1d	14.000	3.00	15.50	17.5
...N/1b	14.300	3.20	15.65	19.5
...N/2	17.287	3.20	18.24	24.0
...N/2a	17.287	4.00	18.94	24.0
...N/2b	17.287	3.00	18.24	24.0
...N/3	22.002	3.99	23.40	28.0
...N/4	25.463	4.78	28.86	36.0
...N/4b	25.463	5.00	28.23	36.0
...N/4a	27.000	4.78	28.80	32.5
...N/4g	28.450	6.00	29.33	38.5
...N/5	33.176	6.38	35.39	44.0
...N/5a	33.176	7.00	35.39	44.0
...N/6	43.057	7.95	46.46	51.0
...N/6a	41.150	8.00	44.25	42.0

Code	Konus 1:5 Taper 1:5			
	Ø d	b	t2	l
A10	9.85	2	10.85	11.5
As12	11.85	3	13.65	16.5
B17	16.85	3	18.90	18.5
C20	19.85	4	22.05	21.5
Cs22	21.95	3	23.75	21.5
D25	24.85	5	27.90	26.5
E30	29.85	6	32.45	31.5
F35	34.85	6	37.45	36.5
G40	39.85	6	42.45	41.5

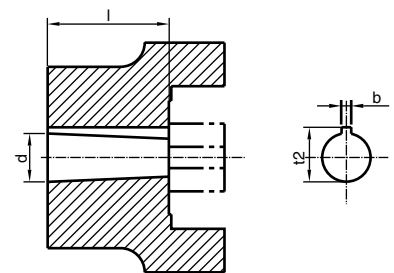

SPIDEX® NBL – spielfreie Wellenkupplung SPIDEX® NBL – backlash-free shaft coupling

- Unter Vorspannung spielfreie Wellenverbindung
- Kleine Baumaße – geringe Schwungmomente
- Wartungsfrei
- Verschiedene Elastomerhärten der Zahnkränze (s.S. 18)
- Fertigbohrung nach ISO-Passung H7 (ausgenommen Klemmnabe), Passfedernut ab Ø 6 mm nach DIN 6885 Bl. 1 -JS9

- Backlash-free, pre-stressed shaft connection
- Compact dimensions – low moment of inertia
- Maintenance-free
- Spiders with various levels of elastomer hardness (see p. 18)
- Finish bore in accordance with ISO fit H7 (except clamping hub), keyway from Ø 6 mm in accordance with DIN 6885 sheet 1 - JS9

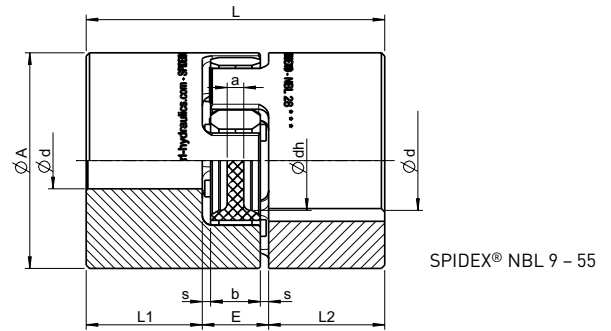

SPIDEX® NBL 9 – 55

Nabenausführungen Types of hubs

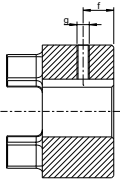

Standard: mit Passfedernut und Gewindestift
Standard
with keyway and set screw

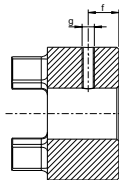

Standard ON: ohne Passfedernut mit Gewindestift
Standard ON
without keyway and set screw

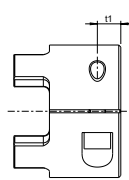

KL: Größen 9 bis 14, einfach geschlitzte Klemmnabe ohne Passfedernut, Drehmoment abhängig vom Bohrungs-Ø.
KL: sizes 9 to 14, single-slot clamping hub without keyway, torque dependent on bore diameter/Ø.

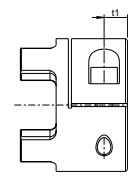
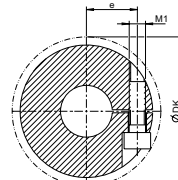

KLD: ab Größe 19, 2-fach geschlitzte Klemmnabe ohne Passfedernut, Drehmoment abhängig vom Bohrungs-Ø.
KLD: from size 19, double-slot clamping hub without keyway, torque dependent on bore diameter/Ø.

SPIDEX® NBL Standardbauarten (Größen 9 – 38: Nabenwerkstoff Aluminium / Größen 42 – 55: Nabenwerkstoff Stahl) SPIDEX® NBL standard versions (sizes 9 – 38: hub material aluminium / sizes 42 – 55: hub material steel)

Größe Size	Maximale Fertigbohrung Ø d für Nabenausführung Maximum finish bore Ø d for hub version		Abmessungen [mm] Dimensions [mm]									Gewindestift DIN 916 für Standardausführung mit und ohne Nut Set screw DIN 916 for standard version with and without keyway		Klemmschraube DIN 912 für Nabenausführung KL und KLD mit und ohne Nut Clamping screw DIN 912 for hub version KL and KLD with and without keyway				
	Standard	KL/KLD	A	d _H	L	L1/L2	E	b	s	a	g	t	M ₁	t ₁	e	D _K	T _A [Nm]	
9	11	11	20	7.2	30	10	10	8	1.0	1.5	M4	5	M2.5	5.0	7.5	23.4	0.76	
14	16	16	30	10.5	35	11	13	10	1.5	2.0	M4	5	M3	5.0	11.5	32.2	1.34	
19	24	24	40	18.0	66	25	16	12	2.0	3.0	M5	10	M6	11.0	14.5	46.0	10.50	
24	28	28	55	27.0	78	30	18	14	2.0	3.0	M5	10	M6	10.5	20.0	57.5	10.50	
28	38	38	65	30.0	90	35	20	15	2.5	4.0	M8	15	M8	11.5	25.0	73.0	25.00	
38	45	45	80	38.0	114	45	24	18	3.0	4.0	M8	15	M8	15.5	30.0	83.5	25.00	
42	55	50	95	46.0	126	50	26	20	3.0	4.0	M8	20	M10	18.0	32.0	93.5	69.00	
48	62	55	105	51.0	140	56	28	21	3.5	4.0	M8	20	M12	21.0	36.0	105.0	120.00	
55	74	68	120	60.0	160	65	30	22	4.0	4.5	M10	20	M12	26.0	42.5	119.5	120.00	

KL.../ON Übertragbare Reibschlussmomente T_R [Nm] der Klemmnabe ohne Passfedernut KL.../ON Transmissible friction torque values T_R [Nm] of the clamping hub without keyway

Größe Size	Ø4	Ø5	Ø6	Ø7	Ø8	Ø9	Ø10	Ø11	Ø12	Ø14	Ø15	Ø16
9	2.1	2.2	2.3	2.4	2.5	2.6	2.7	2.8				
14		4.7	4.8	5.0	5.1	5.3	5.5	5.6	5.8	6.1	6.3	6.5

KLD.../ON Übertragbare Reibschlussmomente T_R [Nm] der Klemmnabe ohne Passfedernut KLD.../ON Transmissible friction torque values T_R [Nm] of the clamping hub without keyway

Größe Size	Ø8	Ø10	Ø11	Ø14	Ø15	Ø16	Ø18	Ø19	Ø20	Ø22	Ø24	Ø25	Ø28	Ø30	Ø32	Ø35	Ø38	Ø40	Ø42	Ø45	Ø48	Ø50	Ø55	Ø60	Ø65
19	25	27	27	29	30	31	32	32	34	30 ¹⁾	32 ¹⁾														
24		34	35	36	38	38	39	40	41	42	43	45	46												
28				80	81	81	84	85	87	89	91	92	97	99	102	105	109								
38					92	94	97	98	99	102	104	105	109	112	113	118	122	123	126	130					
42										232	238	244	246	255	260	274	283	288	294	301	309	315			
48												393	405	413	421	434	445	454	462	473	486	494	414		
55															473	486	498	507	514	526	539	547	567	587	608

1) Klemmnabe 1-fach geschlitzt mit 2 x Klemmschrauben M4 und Maß e = 15
1) Single-slot clamping hub with 2 x clamping screws M4 and dimension e = 15

NBL-Zahnkränze

NBL spiders



Zahnkranz Polyurethan 92° Shore A NBL Spider polyurethane 92° Shore A NBL

- Gelb *Yellow*
- Dauertemperatur -40 bis +90 °C
Continuous temperature -40 to +90 °C
- Max. Temperatur kurzzeitig -50 bis +120 °C
Max. short-term temperature -50 to +120 °C
- Für Antriebe von elektrischen Mess- und Regelsystemen
For drives of electrical measurement & control systems

Zahnkranz Polyurethan 98° Shore A NBL Spider polyurethane 98° Shore A NBL

- Rot *Red*
- Dauertemperatur -30 bis +90 °C
Continuous temperature -30 to +90 °C
- Max. Temperatur kurzzeitig -40 bis +120 °C
Max. short-term temperature -40 to +120 °C
- Positionierantriebe
Positioning motors
- Hauptspindelantriebe bei hoher Beanspruchung
Main spindle drives with high loads

Zahnkranz Polyurethan 64° Shore D NBL Spider polyurethane 64° Shore D NBL

- Grün *Green*
- Dauertemperatur -20 bis +110 °C
Continuous temperature -20 to +110 °C
- Max. Temperatur kurzzeitig -30 bis +120 °C
Max. short-term temperature -30 to +120 °C
- Hohe Belastbarkeit mit geringem Verdrehwinkel
High loading with low torsion angle

Technische Daten

Technical data

Größe Size	Zahnkranz Spider	Drehmoment Torque [Nm]		Max. Drehzahl Max. RPM n [1/min]		Statische Drehfedersteife Static torsional rigidity [Nm/rad] bei 0.50 T _{KN}	Dynamische Drehfedersteife Dynamic torsional rigidity [Nm/rad] bei 0.50 T _{KN}	Radiale Steifheit Radial rigidity [Nm/mm]	Gewicht Weight [kg]		Massenträgheitsmoment J Moment of inertia J [kg m ²]	
		Nenn Contin. T _{KN}	Maximal Maximum T _{Kmax}	Standard Standard	KL/KLD				Nabe Hub (x 10 ⁻³)	Zahnkranz Spider (x 10 ⁻³)	Nabe Hub (x 10 ⁻⁶)	Zahnkranz Spider (x 10 ⁻⁶)
NBL9	92° Shore A	3.0	6.0	19000	23800	31.5	95	262	8	1.7	0.480	0.085
	98° Shore A	5.0	10.0			51.6	155	518				
NBL14	92° Shore A	7.5	15.0	12700	15900	114.6	344	336	20	4.6	2.800	0.457
	98° Shore A	12.5	25.0			171.9	513	654				
NBL19	92° Shore A	10.0	20.0	9550	11900	573.0	1720	1120	66	7.0	20.400	1.490
	98° Shore A	17.0	34.0			859.5	2580	2010				
NBL24	92° Shore A	35.0	70.0	6950	8850	1432.0	4296	1480	132	18.0	50.800	7.500
	98° Shore A	60.0	120.0			2063.0	6189	2560				
	64° Shore D	75.0	150.0			2978.0	8934	3696				
NBL28	92° Shore A	95.0	190.0	5850	7350	2292.0	6876	1780	253	29.0	200.300	16.500
	98° Shore A	160.0	320.0			3438.0	10314	3200				
	64° Shore D	200.0	400.0			4350.0	13050	4348				
NBL38	92° Shore A	190.0	380.0	4750	5950	4584.0	13752	2350	455	49.0	400.600	44.600
	98° Shore A	325.0	650.0			7160.0	21486	4400				
	64° Shore D	405.0	810.0			10540.0	31620	6474				
NBL42	92° Shore A	265.0	530.0	4000	5000	6300.0	14490	2430	1850	79.0	2246.000	100.000
	98° Shore A	450.0	900.0			19200.0	48000	5570				
	64° Shore D	560.0	1120.0			27580.0	68950	7270				
NBL48	92° Shore A	310.0	620.0	3600	4550	7850.0	18055	2580	2520	98.0	3786.000	200.000
	98° Shore A	525.0	1050.0			22370.0	55925	5930				
	64° Shore D	655.0	1310.0			36200.0	90500	8274				
NBL55	92° Shore A	410.0	820.0	3150	3950	9500.0	21850	2980	3800	115.0	7496.000	300.000
	98° Shore A	685.0	1370.0			23800.0	59500	6686				
	64° Shore D	825.0	1650.0			41460.0	103650	9248				

Bestellbezeichnungen für SPIDEX® NBL

Order description for SPIDEX® NBL

SPIDEX® KLD AI NBL 38/45 25H7 ON L = 20 SO

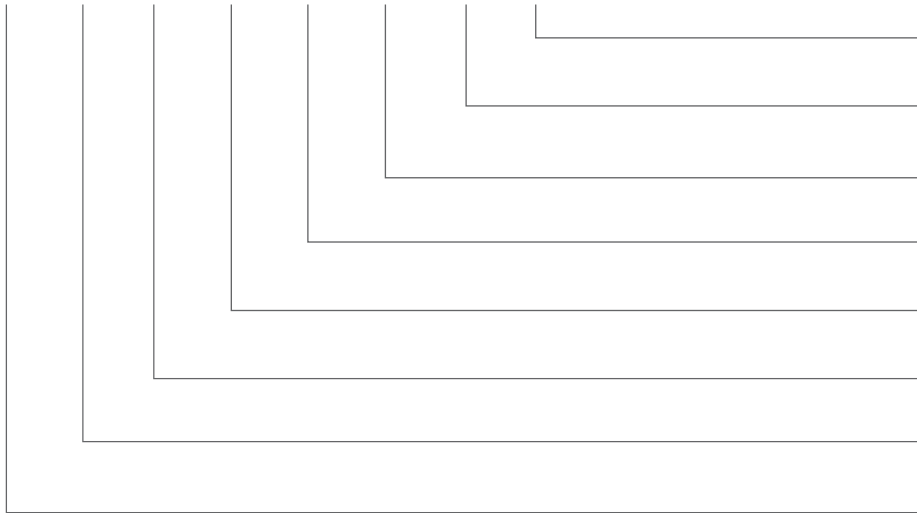

Sonderausführungen
Special designs

Nabenlänge
Length of hub

Nabenbohrung, Zusatz
Hub bore, supplement

Nabenbohrung, Grundform
Hub bore, basic form

Baugröße
Size

Typ
Type

Nabenwerkstoff
Material of hub

Nabenausführung
Design of hub

Erläuterung zum Bestellschlüssel *Explanation of order code*

Nabenausführungen *Design of hubs*

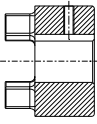
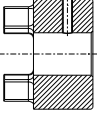
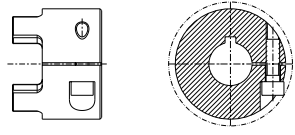
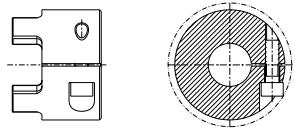
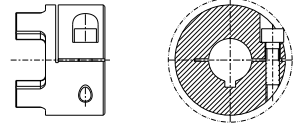
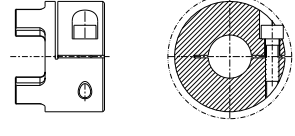
Ausführung <i>Design</i>	Bestellschlüssel <i>Order code</i>	Beschreibung <i>Description</i>	Beispiel <i>Example</i>
Standard <i>Standard</i>	-	- zylindrische Bohrung mit Passfedernut nach DIN 6885/1 - cylindrical bore with keyway in accordance with DIN 6885/1	
	-...-ON	- zylindrische Bohrung ohne Passfedernut - cylindrical bore without keyway	
Klemmnabe, einfach geschlitzt <i>Clamping hub, single slot</i>	KL	- zylindrische Bohrung mit Passfedernut nach DIN 6885/1 - Nabe einfach geschlitzt mit seitlicher Klemmschraube - cylindrical bore with keyway in accordance with DIN 6885/1 - single-slot hub with lateral clamping screw	
	KL-...-ON	- zylindrische Bohrung ohne Passfedernut - Nabe einfach geschlitzt mit seitlicher Klemmschraube - cylindrical bore without keyway - single-slot hub with lateral clamping screw	
Klemmnabe, doppelt geschlitzt <i>Clamping hub, double slot</i>	KLD	- zylindrische Bohrung mit Passfedernut nach DIN 6885/1 - Nabe doppelt geschlitzt mit seitlicher Klemmschraube - cylindrical bore with keyway in accordance with DIN 6885/1 - double-slot hub with lateral clamping screw	
	KLD-...-ON	- zylindrische Bohrung ohne Passfedernut - Nabe doppelt geschlitzt mit seitlicher Klemmschraube - cylindrical bore without keyway - double-slot hub with lateral clamping screw	

DENTEX®/DENTEX® FL – die flexible Kupplung

DENTEX®/DENTEX® FL – the flexible coupling

- Ausgleich axialer, radialer und winkliger Wellenverlagerungen durch doppelkardanische Wirkungsweise
- Einfache, zeitsparende Montage
- Sehr gutes elektrisches Isoliervermögen
- Hohe thermische Beständigkeit
- Wartungsfrei

- Compensation of axial, radial and angular misalignment of shafts through double cardanic action
- Quick and easy assembly
- Excellent electrical insulating properties
- High thermal stability
- No maintenance



DENTEX®-Kupplungen für IEC-Normmotoren

DENTEX® couplings for IEC-standard motors

Motor- bau- größe Motor size	Welle Shaft D x l [mm]		n = 750 [1/min] Leistung P Power P		DENTEX®		n = 1000 [1/min] Leistung P Power P		DENTEX®		n = 1500 [1/min] Leistung P Power P		DENTEX®		n = 3000 [1/min] Leistung P Power P		DENTEX®	
	1500 [1/min]	3000 [1/min]	[kW]	T _{AN} [Nm]	T _K max [Nm]	T _K max [Nm]	[kW]	T _{AN} [Nm]	T _K max [Nm]	T _K max [Nm]	[kW]	T _{AN} [Nm]	T _K max [Nm]	T _K max [Nm]	[kW]	T _{AN} [Nm]	T _K max [Nm]	T _K max [Nm]
56	9 x 20		–	–	14	20	0.037	0.43	14	20	0.06	0.40	14	20	0.09	0.30	14	20
							0.045	0.52			0.09	0.60			0.12	0.40		
63	11 x 23		–	–	14	20	0.060	0.70	14	20	0.12	0.90	14	20	0.18	0.60	14	20
							0.090	1.10			0.18	1.20			0.25	0.90		
71	14 x 30		0.09	1.4	14	20	0.180	2.00	14	20	0.25	1.80	14	20	0.37	1.30	14	20
			0.12	1.8			0.250	2.80			0.37	2.50			0.55	1.90		
80	19 x 40		0.18	2.5	19	32	0.370	3.70	19	32	0.55	3.70	19	32	0.75	2.50	19	32
			0.25	3.5			0.550	5.50			0.75	5.00			1.10	3.70		
90 S	24 x 50		0.37	5.3	24	40	0.750	7.90	24	40	1.10	7.50	24	40	1.50	4.90	24	40
90 L			0.55	7.9			1.100	11.00			1.50	10.00			2.20	7.40		
100 L	28 x 60		0.75	11.0	28	90	1.500	15.00	28	90	2.20	15.00	28	90	3.00	9.80	28	90
			1.10	16.0			1.500	15.00			3.00	20.00			4.00	13.00		
112 M	28 x 60		1.50	21.0	28	90	2.200	22.00	28	90	4.00	27.00	28	90	4.00	13.00	28	90
132 S	38 x 80		2.20	29.0	38	160	3.000	30.00	38	160	5.50	36.00	38	160	5.50	18.00	38	160
							4.000	39.00			7.50	49.00			7.50	25.00		
132 M			3.00	40.0			5.500	55.00			–	–			–	–		
160 M	42 x 110		4.00	54.0	42	200	7.500	74.00	42	200	11.00	72.00	42	200	11.00	35.00	42	200
			5.50	74.0			11.000	108.00			15.00	98.00			15.00	49.00		
160 L			7.50	100.0			–	–			18.50	121.00			18.50	60.00		
180 M	48 x 110		–	–	48	280	–	–	48	280	22.00	144.00	48	280	22.00	72.00	48	280
180 L			11.00	147.0			15.000	147.00			22.00	144.00			–	–		
200 L	55 x 110		15.00	196.0	55	500	18.500	185.00	55	500	30.00	195.00	55	500	30.00	97.00	55	500
							22.000	215.00			37.00	117.00			37.00	117.00		
225 S	60 x 140		18.50	245.0	65	780	–	–	65	780	37.00	245.00	65	780	–	–	65	780
225 M		55 x 110	22.00	294.0			30.000	292.00			45.00	294.00			45.00	146.00		
250 M	65 x 140	60 x 140	30.00	390.0	65	780	37.000	361.00	65	780	55.00	357.00	65	780	55.00	176.00	65	780
280 S	75 x 140		37.00	490.0	80	1400	45.000	440.00	80	1400	75.00	487.00	80	1400	75.00	245.00	80	1400
280 M		65 x 140	45.00	585.0			55.000	536.00			90.00	584.00			90.00	294.00		
315 S	80 x 170		55.00	715.0	80	1400	75.000	730.00	80	1400	110.00	714.00	80	1400	110.00	350.00	80	1400
315 M			75.00	970.0			90.000	876.00			132.00	857.00			132.00	420.00		
315 L			90.00	1170.0	100	2400	110.000	1070.00	100	2400	160.00	1030.00	100	2400	160.00	513.00	80	1400
			110.00	1420.0			132.000	1280.00			200.00	1290.00			200.00	641.00		

Technische Daten

Technical data

Typ Type	Drehzahl Rotation	Drehmoment Torque		Leistung P Power P		Verlagerung max Misalignment max		
		n max [1/min]	[Nm]	[kW/min-1]	axial axial [mm]	radial radial [mm]	winklig angular [Grad]	
		T _{KN}	T _K max	Nenn	max			
B-14	8000	10	20	0.0010	0.0021	± 1	± 0.3	± 1
B-19	8000	16	32	0.0017	0.0033			
B-24	8000	20	40	0.0021	0.0042			
B-28	8000	45	90	0.0047	0.0094			
B-32	7000	60	120	0.0063	0.0130			
B-38	6000	80	160	0.0084	0.0170			
B-42	5400	100	200	0.0100	0.0200			
B-48	5000	140	280	0.0150	0.0290			
B-55	4000	250	500	0.0260	0.0520			
B-65	3800	390	780	0.0410	0.0800			
B-80	3000	700	1400	0.0730	0.1500			
B-100	2400	1250	2400	0.1300	0.2500			
B3R	24	10200	20	40	0.0020	0.0040	± 0.4	
	28	8300	45	90	0.0045	0.0095		
B3R	32	7000	80	160	0.0084	0.0170		
B4R	45	5000	140	280	0.0150	0.0290		
	65	3800	390	780	0.0410	0.0800		
	80	3000	700	1400	0.0730	0.1500		
	100	2400	1250	2400	0.1300	0.2500		

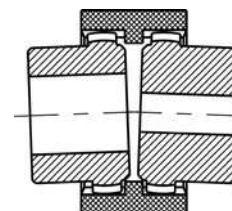

Verlagerung winklig
Misalignment angular

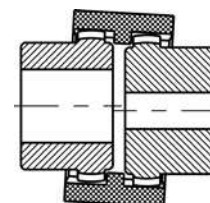

Verlagerung radial
Misalignment radial

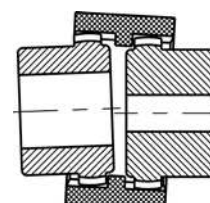

Verlagerung winklig-radial
Misalignment angular-radial

DENTEX®-Kupplungen, Serie B

DENTEX® couplings, series B

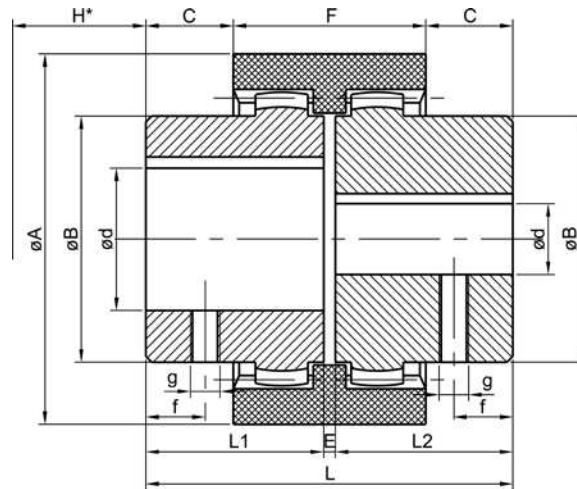

Technische Daten

Technical data

Typ Type	Vorbohrung Prebored	Fertigbohrung Finish bore d [mm]		Abmessungen Dimensions [mm]										Sonderlänge Extended hub length	Gewicht Weight [kg]	Massenträgheitsmoment Moment of inertia J [kg m ²]
		min	max	A	B	L	L1/L2	E	H*	C	F	g	f			
B-14	5	6	14	40	25	50	23	4	15	6.5	37	M5	6	40	0.175	0.000030
B-19	8	9	19	48	30	54	25	4	17	7.0	37	M5	6	–	0.320	0.000470
B-24	9	10	24	52	36	56	26	4	17	7.5	41	M5	6	50	0.316	0.000093
B-28	9	10	28	66	44	84	40	4	20	19.0	46	M8	10	55	0.739	0.000310
B-32	11	12	32	76	50	84	40	4	20	18.0	48	M8	10	55	0.950	0.000550
B-38	12	14	38	83	58	84	40	4	20	18.0	48	M8	10	60	1.220	0.000870
B-42	16	20	42	92	65	88	42	4	22	19.0	50	M8	10	60	1.490	0.001400
B-48	16	20	48	100	68	104	50	4	22	27.0	50	M8	10	60	1.810	0.001800
B-55	–	25	55	125	83	124	60	4	30	30.0	65	M10	20	–	3.450	0.004600
B-65	0/30	10/32	65	140	96	144	70	4	32	36.0	72	M10	20	–	5.180	0.009900
B-80	–	30	80	175	124	186	90	6	45	46.5	93	M10	20	–	11.500	0.037000
B-100	35	40	100	210	152	228	110	8	55	63.0	102	M12	30	–	20.500	0.115600

H* ist das Mindestmaß, um welches die Aggregate auseinander geschoben werden müssen, um einen radialen Ausbau zu ermöglichen. Fertigbohrung nach ISO-Passung H7, Passfedernut nach DIN 6885, Blatt 1 (JS9). Gewicht und Massenträgheitsmoment beziehen sich auf den maximal möglichen Durchmesser d ohne Nut.

H* is the minimum dimension required for the disassembly of the aggregates in a radial direction. Finish bore acc. to ISO standard H7, keyway acc. to DIN 6885, sheet 1 (JS9). Weight and moment of inertia values refer to maximum diameter d without keyway.

Montagehinweis

Assembly instruction

Bei Montage der Kupplung ist zu beachten, dass die Naben mit den Wellenenden bündig sind und das E-Maß eingehalten wird. Das E-Maß lässt sich anhand der Gesamtbaulänge L kontrollieren. Ein nicht exakt eingehaltenes E-Maß hat negativen Einfluss auf die Funktion der Kupplung. Vor Inbetriebnahme der Kupplung ist zu prüfen, ob die Verbindungshülse leicht axial verschiebbar ist. Die zulässigen Verlagerungswerte sind abhängig von Drehzahl und Leistung.

On assembly it is important that the hubs are correctly fitted on the shafts and that the dimension E is maintained. The dimension E can be checked by the total assembly length L. An inexact dimension E has a negative influence on the performance of the coupling. Check that axial movement of the coupling sleeve can be effected easily before operating the coupling for the first time. The permissible displacement values are dependent on rotation and transmitted power.

DENTEX®-Kupplungen, Serie B3R mit Innen- und Außen-Seegerringen

DENTEX® couplings, series B3R with inner and outer Seeger circlips

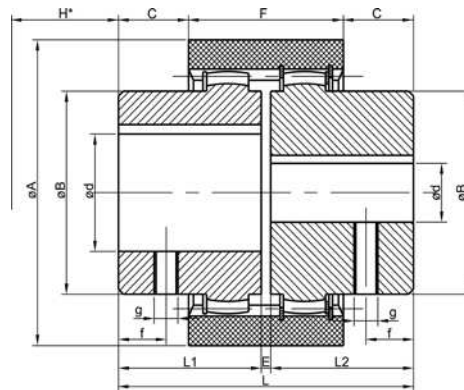

Typ B3R
Type B3R

Technische Daten

Technical data

Typ Type	Fertigbohrung Finish bore d [mm]		Abmessungen Dimensions [mm]										Gewicht Weight [kg]	Massenträgheits- moment Moment of inertia J [kg m ²]
	min	max	A	B	L	L1/L2	E	H*	C	F	g	f		
B3R 24	10	24	58	36	56	26	4	23.5	2.5	51	M5	6	0.3	0.0001
B3R 28	10	28	70	44	84	40	4	26.0	14.0	56	M8	10	0.8	0.0004
B3R 32	12	32	84	50	84	40	4	27.0	13.0	58	M8	10	1.1	0.0007
B3R 45	20	42	100	65	88	42	4	28.0	14.0	60	M8	10	1.5	0.0016
B3R 65	25	65	140	96	144	70	4	40.0	30.0	84	M10	20	5.4	0.0115
B3R 80	30	80	175	124	186	90	6	45.0	46.5	93	M10	20	11.6	0.0378
B3R 100	40	100	210	152	228	110	8	49.0	63.0	102	M12	30	20.7	0.0974

H* ist das Mindestmaß, um welches die Aggregate auseinander geschoben werden müssen, um einen radialen Ausbau zu ermöglichen. Fertigbohrung nach ISO-Passung H7, Passfedernut nach DIN 6885, Blatt 1 (JS9). Gewicht und Massenträgheitsmoment beziehen sich auf den maximal möglichen Durchmesser d ohne Nut.

H* is the minimum dimension required for the disassembly of the aggregates in a radial direction. Finish bore acc. to ISO standard H7, keyway acc. to DIN 6885, sheet 1 (JS9). Weight and moment of inertia values refer to maximum diameter d without keyway.

DENTEX®-Kupplungen, Serie B4R mit außenliegenden Anlauf- und Seegerringen

DENTEX® couplings, series B4R with outer bearing rings and Seeger circlips

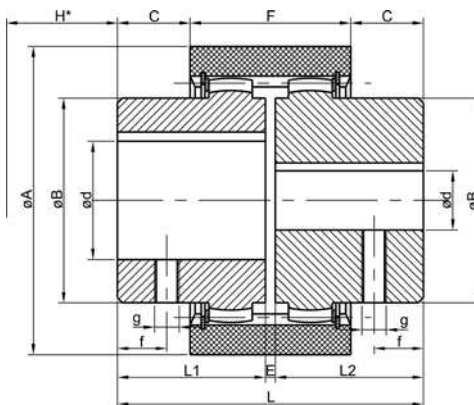

Typ B4R
Type B4R

Technische Daten

Technical data

Typ Type	Fertigbohrung Finish bore d [mm]		Abmessungen Dimensions [mm]										Gewicht Weight [kg]	Massenträgheits- moment Moment of inertia J [kg m ²]
	min	max	A	B	L	L1/L2	E	H*	C	F	g	f		
B4R 32	12	32	84	50	84	40	4	18.0	13.0	58	M8	10	1.1	0.0007
B4R 45	20	42	100	65	88	42	4	18.0	14.0	60	M8	10	1.5	0.0017
B4R 65	25	65	140	96	144	70	4	15.0	30.0	84	M10	20	5.4	0.0118
B4R 80	30	80	175	124	186	90	6	3.5	46.5	93	M10	20	11.7	0.0385
B4R 100	40	100	210	152	228	110	8	-	63.0	102	M12	30	20.8	0.0987

H* ist das Mindestmaß, um welches die Aggregate auseinander geschoben werden müssen, um einen radialen Ausbau zu ermöglichen. Fertigbohrung nach ISO-Passung H7, Passfedernut nach DIN 6885, Blatt 1 (JS9). Gewicht und Massenträgheitsmoment beziehen sich auf den maximal möglichen Durchmesser d ohne Nut.

H* is the minimum dimension required for the disassembly of the aggregates in a radial direction. Finish bore acc. to ISO standard H7, keyway acc. to DIN 6885, sheet 1 (JS9). Weight and moment of inertia values refer to maximum diameter d without keyway.

Basisprogramm metrische Bohrungen und Zollbohrungen Standard metric bores and standard inch bores

Basisprogramm metrische Bohrungen *Standard metric bores*

Typ Type	Fertigbohrung nach ISO-Passung H7, Passfedernut nach DIN 6885, Blatt 1 (JS9) <i>Finish bore acc. to ISO standard H7, keyway acc. to DIN 6885, sheet 1 (JS9)</i>																																						
	6	7	8	9	10	11	12	14	15	16	17	18	19	20	22	24	25	28	30	32	35	38	40	42	45	48	50	55	60	65	70	75	80	85	90	100			
B-14	x	x	x	x	x	x	x	x																															
B-24																																							
B-28						x	x	x	x	x	x	x	x	x	x	x	x	x																					
B-32																																							
B-38																																							
B-42																																							
B-48																																							
B-55																																							
B-65																																							
B-80																																							
B-100																																							
B3R 45																																							
B4R 45																																							

Basisprogramm Zollbohrungen *Standard inch bores*

Typ Type	V	TA	DNC	DNH	Ad	AS	A	G	GS	F	B	Bs	H	Hs	Sb	Sd	Js	K	M	C	N	L	KS	NM	D	P	W												
B-14																																							
B-24		x			x	x	x	x		x																													
B-28	x	x		x	x	x	x	x		x		x		x	x	x																							
B-32																																							
B-38																																							
B-42																																							
B-48																																							
B-55																																							
B-65																																							
B-80																																							
B-100																																							

Abmessungen Zollbohrungen *Dimensions inch bores*

Code	Ø d [mm]	b [mm]	t2 [mm]	Code	Ø d [mm]	b [mm]	t2 [mm]	Code	Ø d [mm]	b [mm]	t2 [mm]
		+0.05	+0.2			+0.05	+0.2			+0.05	+0.2
V	11.110 H7	3.18	12.34	G	22.22 +0.030	4.75	24.70	C	38.070 +0.030	9.55	43.0
TA	12.700 +0.030	3.17	14.30	F	22.22 +0.030	6.35	25.20	N	41.290 +0.030	9.55	46.1
DNC	13.450 H7	3.17	14.90	B	25.37 +0.030	4.78	27.80	L	44.450 +0.030	11.11	49.5
S	15.870 +0.030	3.97	17.90	BS	25.38 +0.030	6.37	28.30	NM	47.625 +0.030	12.73	53.4
E	15.870 +0.030	3.17	17.50	H	25.40 +0.030	4.78	27.80	DS	50.770 +0.030	12.73	56.4
ES	15.880 +0.030	4.00	17.70	SB	28.60 +0.020	6.35	32.10	D	50.800 +0.030	12.73	55.1
Ed	15.890 +0.020	4.75	18.30	SD	28.58 +0.030	7.93	32.10	P	53.950 +0.030	12.73	59.6
DNH	17.465 H7	4.75	19.60	JS	31.75 +0.030	6.35	34.62	W	60.370 +0.030	15.87	68.8
Ad	19.020 +0.030	3.17	20.70	K	31.75 K7	7.93	35.50	WN	73.025 +0.030	19.05	83.0
AS	19.020 +0.030	4.78	21.30	KS	31.75 +0.030	7.93	36.60	WA	85.780 +0.030	22.22	97.3
A	19.050 +0.030	4.78	21.30	M	34.94 +0.030	7.93	39.00	WK	92.080 +0.030	22.22	103.3

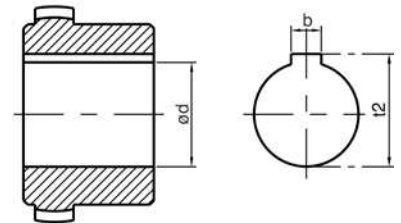

Kegelige Bohrungen *Tapered bores*

Code	Konus 1:8 Taper 1:8			
	Ø d	b	t2	l
...N/1	9.75	2.40	10.7	17.0
...N/1c	11.60	3.00	12.9	16.5
...N/1e	13.00	2.40	13.8	21.0
...N/1d	14.00	3.00	15.5	17.5
...N/1b	14.30	3.20	15.7	19.5
...N/2	17.28	3.20	18.2	24.0
...N/2a	17.28	4.00	18.9	24.0
...N/3	22.00	4.00	23.4	28.0
...N/4	25.46	4.78	27.8	36.0
...N/4b	25.46	5.00	28.2	36.0
...N/4a	27.00	4.78	28.8	32.5
...N/4g	28.45	6.00	29.3	38.5
...N/5	33.17	6.38	35.4	44.0
...N/5a	33.17	7.00	35.4	44.0
...N/6	43.05	7.95	46.5	51.0
...N/6a	41.15	8.00	44.2	42.5

Code	Konus 1:5 Taper 1:5			
	Ø d	b	t2	l
A10	9.85	2	10.9	11.5
B17	16.85	3	18.9	18.5
C20	19.85	4	220.0	21.5
Cs22	21.95	3	23.8	21.5
D25	24.85	5	27.9	26.5
E30	29.85	6	32.5	31.5
F35	34.85	6	37.5	36.5
G40	39.85	6	45.5	41.5

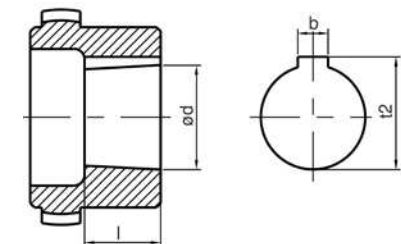

Naben mit Profilverzahnung nach DIN 5480, DIN 5482 und SAE erhältlich.
Hubs with spline acc. to DIN 5480, DIN 5482 and SAE available.

DENTEX® FL-Kupplungen – drehstarre Flanschkupplungen für dieselmotorische Antriebe

DENTEX® FL couplings – torsionally rigid flange couplings for diesel driven units

- Minimale Einbaulänge
 - Blindmontage durch axiales Zusammenstecken
 - Wartungsfrei durch Werkstoffpaarung Kunststoff/Stahl
 - Glasfaserverstärkter Polyamidflansch hitzebeständig bis +120 °C
 - Hohes Axialspiel von ± 2 mm schützt die benachbarten Wellenlager vor auftretenden Lagerkräften
 - Sonderflansche lieferbar
 - Hohe Drehsteifigkeit – resonanzfreier Betrieb
- Minimum mounting length
 - Blind mounting through push-fit assembly
 - Maintenance-free on account of the steel/plastic combination
 - Glass-fibre reinforced polyamide coupling sleeve heat resistant up to +120 °C
 - High axial play of ± 2 mm protecting neighbouring shaft bearings from additional loads
 - Special flanges available
 - High torsional rigidity – resonance-free operation

Die glasfaserverstärkten Polyamid-Flansche der DENTEX® FL-Kupplungen basieren auf den genannten SAE-Anschlussmaßen für alle gängigen Dieselmotoren. Die DENTEX® FL-Kupplung ermöglicht eine formschlüssige Verbindung zwischen Dieselmotor und Hydraulikpumpe. Die Pumpenzentrierung erfolgt über das SAE-Gehäuse. Falls bei Pumpenwellen mit Profilverzahnung (DIN 5480, 5482, SAE) eine Naben-sicherung durch Endscheibe und Schraube nicht möglich ist, sollte die Verwendung einer Klemmnabenverbindung vorgesehen werden. Die radiale Verspannung gewährleistet einen spielfreien Sitz auf der Pumpenwelle.

The glass-fibre reinforced polyamide coupling flange of the DENTEX® FL couplings are based on the above mentioned mounting clearances for all conventional diesel motors. The DENTEX® FL coupling allows a keyed connection between diesel motor and hydraulic pump. The pump is centred via the SAE housing. Should the securing of the hub by means of end-disc and screw not be possible in the case of pump shafts with profiled gear teeth (acc. to Standardization DIN 5480, 5482, SAE), the use of a clamping hub connection should be considered. The radial distortion guarantees a backlash-free fit on the pump shaft.

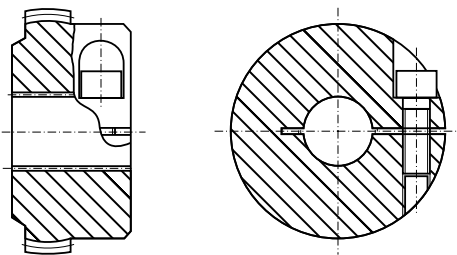

Bestellbeispiel: Bauart und Kupplungsgröße DENTEX® 48 FL, SAE-Flanschgröße 10, Fertigungsbohrung und Nabenlänge Ø 40 x 50

Ordering example: Type and clutch size DENTEX® 48 FL, SAE flange size 10, manufacturing bore and hub length Ø 40 x 50

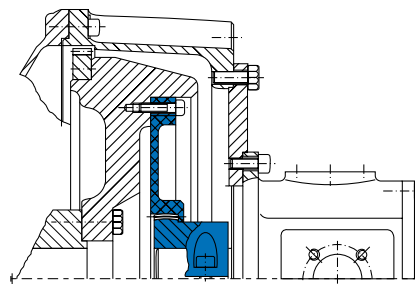

Typisches Einbaubeispiel für eine DENTEX® FL-Kupplung zwischen Dieselmotor und Hydraulikpumpe

Typical example for an installation of a DENTEX® FL coupling between diesel motor and hydraulic pump

Technische Daten Technical data

Größe* Size*	Drehmoment in [Nm] Torque in [Nm]			Nabe bei max. Bohr-Ø Hub at max. bore Ø		Flansche nach SAE Flanges SAE					Drehfedersteife Dynamic torsional stiffness [Nm/rad]	
	T _{KN}	T _{Kmax}	T _{KW}	Massenträgheitsmoment J [kg m ²] Moment of inertia J [kg m ²]	Gewicht [kg] Weight [kg]	6 1/2"	7 1/2"	8"	10"	11 1/2"		14"
42	240	480	120	0.0006	0.675	0.4000	0.5200	0.5000	0.7500			0.30 T _{KN} = 35 x 10 ³ 0.50 T _{KN} = 75 x 10 ³ 0.75 T _{KN} = 105 x 10 ³ 1.00 T _{KN} = 125 x 10 ³
						0.0025	0.0045	0.0048	0.0100			
48	240	480	120	0.0007	0.790	0.3200	0.4300	0.5100	0.6400			0.30 T _{KN} = 35 x 10 ³ 0.50 T _{KN} = 75 x 10 ³ 0.75 T _{KN} = 105 x 10 ³ 1.00 T _{KN} = 125 x 10 ³
						0.0021	0.0035	0.0049	0.0085			
65	650	1600	325	0.0039	2.190				0.6400	0.8900		0.30 T _{KN} = 110 x 10 ³ 0.50 T _{KN} = 160 x 10 ³ 0.75 T _{KN} = 200 x 10 ³ 1.00 T _{KN} = 230 x 10 ³
									0.0065	0.0120		
80	1200	3000	600	0.0151	5.200					1.1200		0.30 T _{KN} = 200 x 10 ³ 0.50 T _{KN} = 410 x 10 ³ 0.75 T _{KN} = 580 x 10 ³ 1.00 T _{KN} = 700 x 10 ³
										0.0220		
80	1200	3000	600	0.0151	5.200						0.7350	0.30 T _{KN} = 200 x 10 ³ 0.50 T _{KN} = 410 x 10 ³ 0.75 T _{KN} = 580 x 10 ³ 1.00 T _{KN} = 700 x 10 ³
											0.1870	

*Hochbelastbare Naben auf Anfrage

*Hubs resistant against high loads are available on request

DENTEX® FL-Kupplungen DENTEX® FL couplings

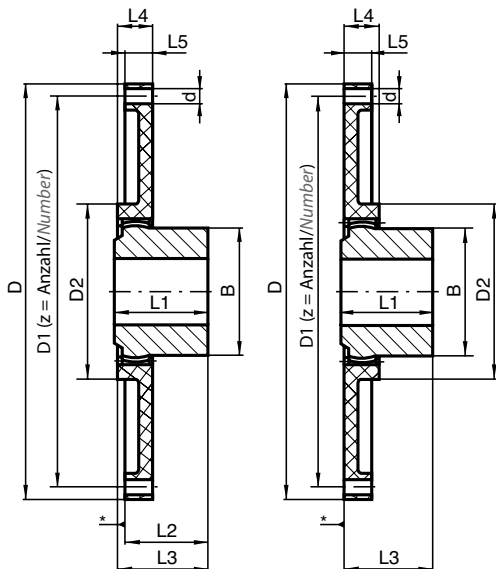

* Anschlagseite Montage kurz
* Stop side mounting short

SAE-Flanschabmessungen (SAE J 620) SAE flange dimensions (SAE J 620)

Nenngröße Nominal dimension	Lochkreis-Ø Circular bore Ø	Außen-Ø Outer Ø	Befestigungsbohrung Ø Clamping borehole Ø	Anzahl Number
	D1 [mm]	D [mm]	[mm]	z
6 1/2"	200.02	215.90	9	6
7 1/2"	222.25	241.30	9	8
8"	244.47	263.52	11	6
10"	295.27	314.32	11	8
11 1/2"	333.37	352.42	11	8
14**	438.15	466.72	14	8

*2-teilig *2-parts

Metrische Flanschabmessungen Metric flange dimensions

Nenngröße Nominal dimension	Lochkreis-Ø Circular bore Ø	Außen-Ø Outer Ø	Befestigungsbohrung Ø Clamping borehole Ø	Zentrier-Ø Centre Ø
	D1 [mm]	D [mm]	[mm]	[mm]
96	50	96	4.0 x 8.0	70
125	100	125	3.0 x 8.0	80
135	100	135	3.0 x 10.5	135
150	130	150	5.0 x 8.0	106
152	122	152	3.0 x 12.0	105
155	125	155	3.0 x 12.0	155
210	185	210	3.0 x 10.0	125
220	165	220	6.0 x 10.0	220
220	185	220	3.0 x 12.0	125

Größen 165, 180 und 252 auf Anfrage Dimensions 165, 180 and 252 on request

Flansch- und Nabenabmessungen SAE Flange and hub dimensions SAE

Größe Size	Fertigbohrung Finish bore		Abmessungen [mm] Dimensions [mm]							Sonderlänge [mm] Special length [mm]	Nennmaß nach SAE [D] Nominal dimension acc. to standardisation SAE [D]					
	min	max	B	D2	L1	L2	L3	L4	L5	L1 max	6 1/2"	7 1/2"	8"	10"	11 1/2"	14"
42	20	42	65	100	42	33	42	20	13	60	x	x	x	x		
48	20	48	68	100	50	41	50	20	13	60	x	x	x	x		
65	25	65	96	132	70	60	70	27	21	-				x		
65	25	65	96	172	70	60	70	31	22	-					x	
80	30	80	124	172	90	78	87	30	21	-					x	x

Auswahltabelle DENTEX® FL-Flanschkupplung Menu table DENTEX® FL flange coupling

Nenngröße Nominal dimension	DENTEX® Naben-Typ DENTEX® hub type	Motorhersteller/Typ (Beispiele) Engine manufacturer (examples)
6 1/2"	B 42/48	Ford, Hatz, KHD, Kubota, Lister Petter, Lombardini, Perkins, Ruggerine, Slanzi, Teledyne
7 1/2"	B 42/48	Ford, Hatz, Isuzu, KHD, Kubota, Lister Petter, Lombardini, Mitsubishi, Perkins, Toyota, Yanmar
8"	B 42/48	Cummins, Ford, Hatz, Isuzu, KHD, Lister Petter, Lombardini, Mitsubishi, Perkins, Peugeot, Slanzi, Teledyne, Toyota
10"	B 42/48	Cummins, Hatz, Isuzu, KHD, Kubota, Lombardini, Lister Petter, Mitsubishi, Perkins, Slanzi, Toyota
10"	B 65	Caterpillar, Cummins, Detroit Diesel, Daimler-Benz, Ford, Hercules, Isuzu, John Deere, KHD, Lister Petter, Perkins, Slanzi
11 1/2"	B 65	Cummins, John Deere, Deutz
14"	B 80	Cummins, John Deere, Deutz
96 mm	B 80	Caterpillar, Lister Petter, Deutz, John Deere, Cummins
125 mm	B 42/48	Hatz Z 788/789/790
135 mm	B 42/48	Kubota-650, 750, 850, 950, V 1100, 1200, Super 5 Serie (905 - 1505), Perkins 103-10
150 mm	B 42/48	Kubota-D600B, Z400, D722, V800, WG600, WG750 (Super Mini Serie), Briggs Daihatsu DM700, DM950
152 mm	B 42/48	Hatz-573, 673, 780, 786, E71, E75, E79 (Lochkreis-Ø/circular bore Ø 122 mm), Perkins-4108, 504-2T/2LR Deutz-F2L511 (Lochkreis-Ø/circular bore Ø 125 mm)
155 mm	B 42/48	Perkins 103-12/13/15, 104-22
210 mm	B 42/45/48	Kubota Super 3 Serie, D1403, D1703, V1903, V2203
220 mm	B 42/45/48	Kubota Super 3 Serie, D1403, D1703, V1903, V2203 (Lochkreis-Ø/circular bore Ø 165 mm und/and Zentrier-Ø/centre bore Ø 220 mm)
220 mm	B 42/45/48	Kubota Super 3 Serie, D1403, D1703, V1903, V2203 (Lochkreis-Ø/circular bore Ø 185 mm und/and Zentrier-Ø/centre bore Ø 125 mm)