

Schaltschrank-Klimatisierung FA

- ✓ Filterlüfter/Austrittsfilter
- ✓ Dachlüfter/Dachentlüftung
- ✓ Kompaktlüfter/Axiallüfter
- ✓ Schaltschrank-Heizungen
- ✓ Thermostate/Hygrostate

FA



Jetzt mit **INTERAKTIVER** Funktion!

Nach Klick auf die Modell-Nr. erhalten Sie sofort das technische Datenblatt dazu angezeigt.



SYSTEMS AND COMPONENTS FOR INDUSTRIAL ENCLOSURES





08-25	FILTER FANS AND ROOF EXHAUST UNITS Air filtering solutions for enclosures	56-63	REGULATORS Temperature and humidity controllers
26-41	FRAME FANS Axial and centrifugal fans for spot cooling	64-70	ENCLOSURE LIGHTS Lighting devices at low energy consumption
42-47	ANTI-CONDENSATION HEATERS Heating resistors to prevent condensation	71-72	ENCLOSURE COMPONENTS Complementary products for equipping electrical cabinets
48-55	COOLING UNITS Thermoelectric units for air cooling and dehumidifying		

Most of our products are available in the industrial engineering software:













How to read the icons























INSULATION CLASSES

 Class I ELECTRICAL CLASS	 Class I AC ELECTRICAL CLASS	 Class II ELECTRICAL CLASS	 Class III DC ELECTRICAL CLASS	 Class F ELECTRICAL CLASS
---	--	--	--	---

ELECTRICAL FEATURES

 NO NO CONTACT	 NC NC CONTACT	 CHANGE-OVER CONTACT	 NO NO NO/NO CONTACT	 NC NO NC/NO CONTACT
 NC NC NC/NC CONTACT				
 DC DC VERSION	 1/3 1/3-PHASE	 1 1-PHASE	 3 3-PHASE	 Multi MULTI VOLTAGE

PROTECTION RATINGS

 IP 20 PROTECTION DEGREE	 IP 21 PROTECTION DEGREE	 IP 23 PROTECTION DEGREE	 IP 24 PROTECTION DEGREE	 IP 30 PROTECTION DEGREE
 IP 40 PROTECTION DEGREE	 IP 44 PROTECTION DEGREE	 IP 50 PROTECTION DEGREE	 IP 51 PROTECTION DEGREE	 IP 54 PROTECTION DEGREE
 IP 54 PROTECTION DEGREE	 IP 55 PROTECTION DEGREE	 IP 56 PROTECTION DEGREE	 Type 1 UL PROTECTION DEGREE	 Type 12 UL PROTECTION DEGREE
 Type 3R UL PROTECTION DEGREE	 Type 4X UL PROTECTION DEGREE	 G2 FILTRATION CLASS	 G3 FILTRATION CLASS	 G4 FILTRATION CLASS
 ISO coarse 30% FILTRATION CLASS	 ISO coarse 55% FILTRATION CLASS	 ISO coarse 75% FILTRATION CLASS		

MOUNTING FEATURES

 External mount EXTERNAL MOUNTING	 Internal mount INTERNAL MOUNTING	 Recessed mount MONTAGGIO INCASSATO	 Partially recessed mount PARTIALLY RECESSED MOUNTING	 Side mount SIDE MOUNTING
 Top mount TOP MOUNTING	 FAST mounting FAST MOUNTING	 DIN RAIL MOUNTING	 NO TOOLS	

PRODUCT FEATURES

 ELECTRONICALLY COMMUTATED TECHNOLOGY	 EMC ELECTROMAGNETIC COMPATIBILITY	 ECO-FRIENDLY	 REVERSIBLE	 SPEED CONTROL
 THERMALLY PROTECTED	 TOUCH-SAFE	 Kit SALE IN KIT	 Erp 2015 ERP 2015	 Filterless FILTERLESS
 Food & beverage FOOD&BEVERAGE	 OUTDOOR APPLICATION	 RoHS ROHS DIRECTIVE	 RESISTANCE TO UV RAYS	

Air flow management

Increasingly often, the causes behind malfunctions or faults in electrical and electronic equipment housed in control panels or fitted as an integral part of a machine, are due to heat problems. In reality, the life span of components depends on the temperature and level of humidity inside the electrical cabinet.

The normal recommended average operating temperature inside a cabinet is 35°C with relative humidity of no more than 60%.

Fandis offers a wide range of solutions for efficiently disposing of dissipated heat from electrical components suitable for different applications.



NATURAL CONVECTION

The use of exhaust filter ensures the passage of air and the removal of heat in a natural manner. This solution can be considered for dissipating low level of heat in dusty environments.



FORCED CONVECTION

Forced ventilation is an inexpensive and efficient solution for preventing the formation of air pockets inside electrical cabinets. The best configuration includes fitting a filter fan to an exhaust filter.

The filter fan positioned at the bottom of the cabinet, conveys filtered cold air from outside (**standard air flow**) while the exhaust filter at the top expels hot air.

The pressure generated inside the enclosure by the ventilation prevents unfiltered air from entering through holes or openings.



An inverted air flow version (**reverse flow**) is also available; filter fan at top and exhaust filter at bottom.

The system can be controlled by a thermostat that turns the fan on when high temperatures are detected.

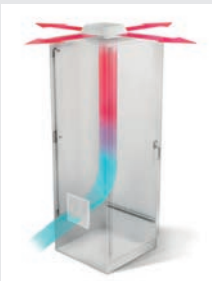
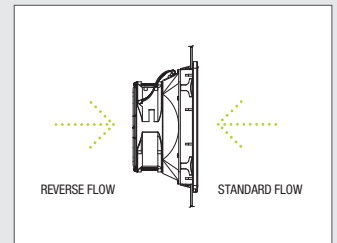

Hot air can also be expelled from the roof of the cabinet if, for instance, the sides of the cabinet are covered by obstacles, walls or by the sides of other cabinets. In a perfect configuration, an exhaust filter is positioned at the bottom of the cabinet. The lower pressure generated by the roof unit draws in cold air from outside through the exhaust filter to enhance internal air flow and the dissipation of heat.



The use of a swivelling fan is an alternative solution for a better air circulation inside the electrical cabinet.

This fan distributes heat to reduce the temperature, cools local hot spots and disperses cold air emitted by cooling units.

Protection ratings

ENVIRONMENTAL TYPE RATINGS

	Definition
Type 1	Primarily indoor use to provide protection against contact with the enclosed equipment and against a limited amount of falling dirt.
Type 12	Indoor use to provide a degree of protection against dust, dirt, fiber flying, dripping water, and external condensation of non-corrosive liquids.
Type 3R	Outdoor use to provide a degree of protection against falling rain; undamaged by the formation of ice on the enclosure.
Type 4X	Either indoor or outdoor use to provide a degree of protection against falling rain, splashing water, and hose-directed water; undamaged by the formation of ice on the enclosure. Corrosion resistant.







Description according to UL50E standard

“IP” PROTECTION DEGREE TABLE

Protection degree against solid foreign object and against access to hazardous parts (1st numeral)

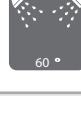
IP	Symbol	Description
0		Non - protected
1		Protected against solid foreign objects at 50 mm Ø or greater and against access to hazardous parts with the back of a hand
2		Protected against solid foreign objects of 12.5 mm Ø or greater and against access to hazardous parts with a finger
3		Protected against solid foreign objects of 2.5 mm Ø or greater and against access to hazardous parts with a tool
4		Protected against solid foreign objects of 1.0 mm Ø or greater and against access to hazardous parts with a wire
5		Dust - protected and protected against access to hazardous parts with a wire
6		Dust - tight and protected against access to hazardous parts with a wire

Protection degree against water (2nd numeral)

IP	Symbol	Description
0		Non - protected
1		Protected against vertically falling water drops
2		Protected against vertically falling water drops at any angle up to 15°
3		Protected against spraying water at any angle up to 60° from the vertical
4		Protected against splashing water from any direction
5		Protected against water jets from any direction
6		Protected against powerful water jets from any direction

Description according to rule CEI EN 60529

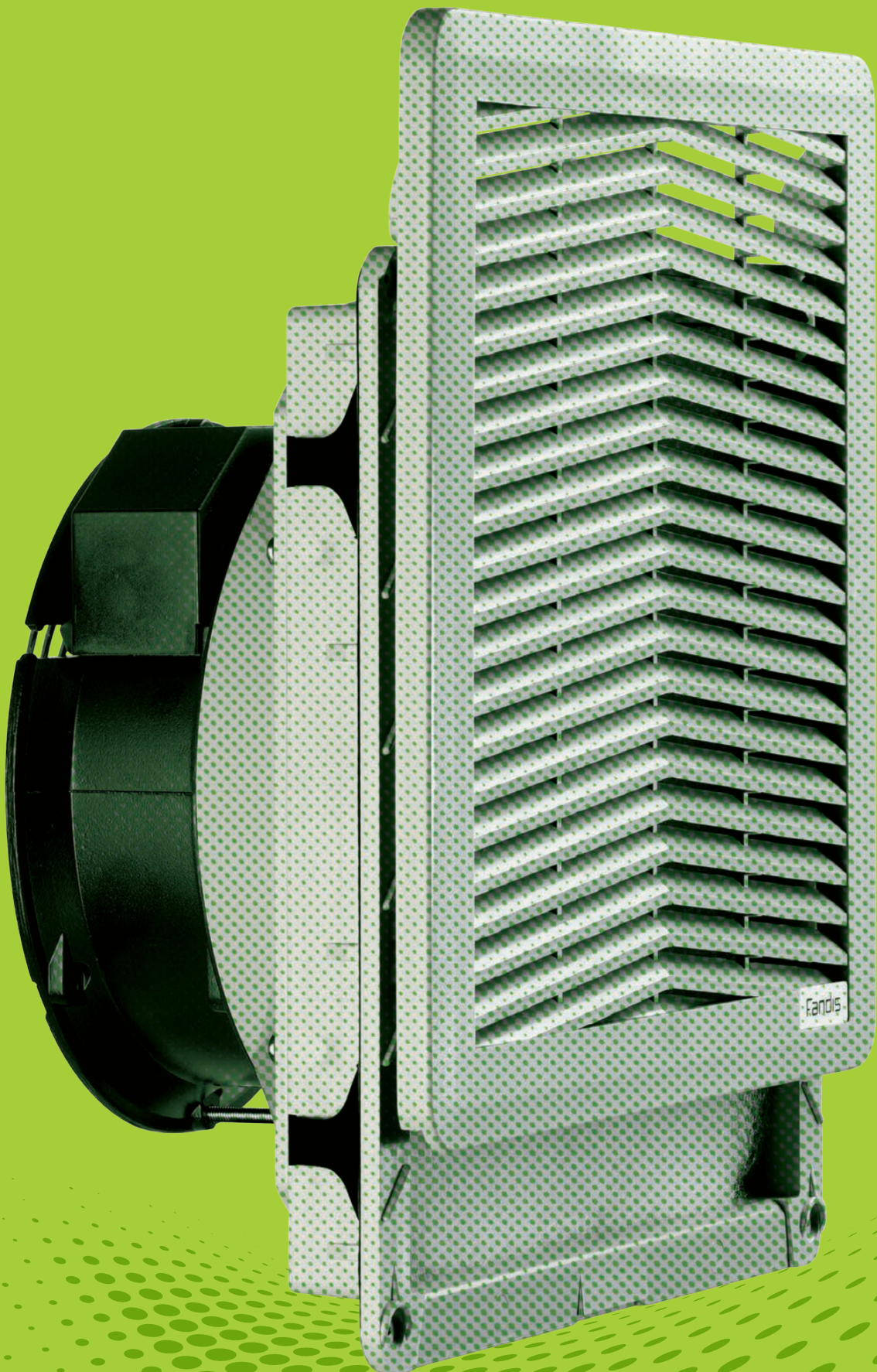

Cooling solutions with filtered ambient air

A practical solution to help the dissipation of heat inside the electrical cabinet and protect electronic components from overheating.

The filter fans channel the cooler, filtered outside air into the cabinet, expelling the heated air through exhaust filters or roof exhaust units.

viridis
fan filters

Most of our products are available
in the industrial engineering software:



■ **FF SERIES** | FILTERS AND FILTERS FANS

The FF series allows practical, tool-less assembly with a clip-on locking system. FF filters and filter fans have a quick electrical connection system and sliding lid opening for easy filter media replacement.



TIME-SAVING INSTALLATION

Quick tool-less assembly system with clips for plates from 1 to 3.7 mm thick

QUICK CONNECTION

Cage clamp tool-less wiring system

IP55 AND TYPE 3R (OPTIONAL)

Ideal for indoor or outdoor use in harsh industrial environments

EMC-COMPATIBLE (OPTIONAL)

Metal shielding for electromagnetic protection

SLIDE OPENING

Easy replacement of the filter media with no need for tools

COLOURS

Standard colour RAL 7035, custom RAL colours subject to minimum order

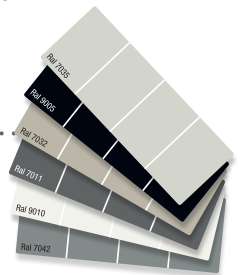

APPROVALS



Details that make the difference



Cage clamp system



Sliding mechanism



Water resistance



TYPE 3R AND IP55

Heat management in the toughest indoor and outdoor applications requires ventilation solutions with high degrees of protection. The IP55 rated FF filters and filter fans are ideal for dusty and humid environments. They are capable of withstanding powerful jets of water from any angle. The UL Type 3R version, on the other hand, is suited for application in outdoor environments where high resistance to weather, temperature variations and premature ageing from UV rays is required. Made of plastic with high glass fibre content, the FF range is more durable and less subject to deterioration and crumbling than common plastic.



EMC SHIELDING

Electromagnetic compatibility (EMC) refers to the property of an electrical device to function properly in a given electromagnetic environment, without adversely affecting it.

As this is an important quality prerogative, designers must take the protection requirements into account already at the equipment drawing-board stage to guarantee the stability and long life of the various electrical components.

The EMC shielding of an electrical cabinet reduces noise emissions and protects internal components from external sources of interference. The Fandis EMC filters and filter fans are designed to restore the protective effect of the cabinet despite the openings made for housing the devices.



Model numbering system for FF SERIES

description	FF 15 P A 230 U N R 5 3 C 1 -S00	description
FAMILY FF		CUSTOM SERIES S** = custom version
DIMENSION CODE (mm) 08 - 107 x 107 12 - 150 x 150 13 - 204 x 204 15 - 250 x 250 20 - 325 x 325		VERSION
FAN SIZE P = small M = medium G = large GE = large with plastic adaptor () = standard		EMC C = EMC shielded
VOLTAGE A = a.c. voltage D = d.c. voltage		TYPE RATING () = Type 12 or Type1 3 = Type 3R
RATED VOLTAGE 115 = 115 Va.c. 230 = 230 Va.c. 400T = 400 Va.c. 3~ 12 = 12 Vd.c. 24 = 24 Vd.c. 48 = 48 Vd.c.		FILTER MAT () = G3 A = G2 5 = G4 O = without
COLOUR R = grey RAL 7032 U = grey RAL 7035 N = black RAL 9005		AIR FLOW DIRECTION () = standard flow R = reverse flow
		FAN SUPPLIER N = NMB E = Ecofit F = Fandis

■ **GF SERIES** | FILTER AND FILTERS FANS

The GF series filter fans are characterized by a jack fixing system suited for application on thick plastic or sheet metal electrical panels. The advantages of the series include quick installation without additional drilling and easy filter replacement, thanks to the swivelling structure of the protective guard.



FIXING WITH JACKS

Patented system for applications on thick plastic or metal wall of cabinets (up to 16mm)



HINGED OPENING

Easy tool-less filter media replacement

Model numbering system for GF SERIES

<i>description</i>	GF 15K P U 230 BE R	<i>description</i>
FAMILY GF		AIRFLOW DIRECTION
DIMENSION CODE (mm) 12 = 150X150 15 = 250x250 20 = 325x325		() = standard R = reverse flow
FAN SIZE P = small G = large () = standard		FAN SUPPLIER B = NMB or Ecofit BE = Fandis
COLOUR U = grey RAL 7035 other colours on request		VOLTAGE 24 = 24 Va.c. D12 = 12 Vd.c. 115 = 115 Va.c. D24 = 24 Vd.c. 230 = 230 Va.c. D48 = 48 Vd.c. 400T = 400 Va.c. 3~ G = no voltage



FF series exhaust filter

- Tool-less assembly system with clips
- Plate thickness: FF08 from 1 to 2mm; FF12, FF13 from 1.3 to 3.2mm; FF15, FF20 from 1.3 to 3.7mm (up to 4mm with cut-out max tolerance)
- Standard colour RAL 7035, other colours available on request, subject to quantity
- Standard protection ratings: IP54 and Type 12. IP55 version, Type 1, 3R and EMC on request



Model	Dimensions mm	Cut-Out mm	Approvals
FF08U	107x107x23	91,5x91,5	cURus; cULus; cCSAus
FF12U	150x150x29	124x124	cURus; cULus; cCSAus
FF13U	204x204x30	177x177	cURus; cULus; cCSAus
FF15U	250x250x34	223x223	cURus; cULus; cCSAus
FF20U	325x325x34	291x291	cURus; cULus; cCSAus



FF series IP55 exhaust filter

- IP55 protection degree for humid, dusty or dirty environments



Model	Dimensions mm	Cut-Out mm	Approvals
FF12U5	150x150x29	124x124	cURus; cULus; cCSAus
FF13U5	204x204x30	177x177	cURus; cULus; cCSAus
FF15U5	250x250x34	223x223	cURus; cULus; cCSAus
FF20U5	325x325x34	291x291	cURus; cULus; cCSAus



FF series EMC exhaust filter

- Metal shielding against electromagnetic interference



Model	Dimensions mm	Cut-Out mm	Approvals
FF08UC	107x107x23	91,5x91,5	cURus; cULus; cCSAus
FF12UC	150x150x29	124x124	cURus; cULus; cCSAus
FF13UC	204x204x30	177x177	cURus; cULus; cCSAus
FF15UC	250x250x34	223x223	cURus; cULus; cCSAus
FF20UC	325x325x34	291x291	cURus; cULus; cCSAus



FF series Type 3R exhaust filter

- Suitable for outdoor applications
- Weather resistant plastics
- UV resistant
- Colour RAL 9005
- IP55 protection degree (IP54 for FF08 series)



Model	Dimensions mm	Cut-Out mm	Approvals
FF08N3	107x107x23	91,5x91,5	cURus; cULus
FF12N53	150x150x29	125x125	cURus; cULus
FF13N53	204x204x30	177x177	cURus; cULus
FF15N53	250x250x34	223x223	cURus; cULus
FF20N53	325x325x34	291x291	cURus; cULus



FF series filter fans

- Tool-less assembly system with clips
- Plate thickness: FF08 from 1 to 2mm; FF12, FF13 from 1.3 to 3.2mm; FF15, FF20 from 1.3 to 3.7mm (up to 4mm with cut-out max tolerance)
- Quick electrical connection by screwless terminal block
- Standard colour RAL 7035, other colours available on request, subject to quantity
- Standard protection ratings: IP54 and Type 12. Optional versions: IP55, Type 1, 3R and EMC on request
- R version (airflow from inside to outside the enclosure)
- Frequency: 50/60Hz



Model	Dimensions mm	Cut-Out mm	Rated Voltage V	Rated Power W	Max Airflow m³/h	Airflow with Exhaust Filter m³/h	Approvals
FF08A							
FF08A115UN	107x107x67	91,5x91,5	115 V a.c.	9/7	12/15	9/11.5	cURus; cULus; cCSAus
FF08A115UNR	107x107x67	91,5x91,5	115 V a.c.	9/7,5	16/21	13/17	cURus; cULus; cCSAus
FF08A230UN	107x107x67	91,5x91,5	230 V a.c.	10/8	12/15	9/11.5	cURus; cULus; cCSAus
FF08A230UNR	107x107x67	91,5x91,5	230 V a.c.	10/8	16/21	13/17	cURus; cULus; cCSAus
FF08D							
FF08D12UN	107x107x54	91,5x91,5	12 V d.c.	2	16	11	cURus; cULus; cCSAus
FF08D24UN	107x107x54	91,5x91,5	24 V d.c.	2	16	11	cURus; cULus; cCSAus
FF08D24UNR	107x107x54	91,5x91,5	24 V d.c.	2,2	23	16	cURus; cULus; cCSAus
FF08GA							
FF08GA115UF	107x107x80	92,5x92,5	115 V a.c.	12/10	21/26	15/19	cURus; cULus; cCSAus
FF08GA230UF	107x107x80	92,5x92,5	230 V a.c.	12/11	21/26	15/19	cURus; cULus; cCSAus
FF08GD							
FF08GD24UN	107x107x77	92,5x92,5	24 V d.c.	15	50	36	cURus; cULus; cCSAus
FF08GD24UNR	107x107x77	92,5x92,5	24 V d.c.	17	60	44	cURus; cULus; cCSAus
FF12A							
FF12A115UF	150x150x73	124x124	115 V a.c.	16/15	45/50	33/36	cURus; cULus; cCSAus
FF12A115UFR	150x150x74	124x124	115 V a.c.	16/15	47/52	37/41	cURus; cULus; cCSAus
FF12A115UN	150x150x73	124x124	115 V a.c.	19/17	67/79	48/54	cURus; cULus; cCSAus
FF12A115UNR	150x150x73	124x124	115 V a.c.	19/17	60/70	45/52	cURus; cULus; cCSAus
FF12A230UF	150x150x73	124x124	230 V a.c.	18/17	45/50	33/36	cURus; cULus; cCSAus

Model	Dimensions	Cut-Out	Rated Voltage	Rated Power	Max Airflow	Airflow with Exhaust Filter	Approvals
	mm	mm	V	W	m³/h	m³/h	
FF12A230UFR	150x150x73	124x124	230 V a.c.	18/17	47/52	37/41	cURus; cULus; cCSAus
FF12A230UN	150x150x73	124x124	230 V a.c.	18/16	67/79	48/54	cURus; cULus; cCSAus
FF12A230UNR	150x150x73	124x124	230 V a.c.	18/16	60/70	45/52	cURus; cULus; cCSAus
FF12A24UF	150x150x73	124x124	24 V a.c.	15/15	39/44	28/31	-
FF12A24UFR	150x150x73	124x124	24 V a.c.	15/15	50/52	38/38	-
FF12D							
FF12D24UN	150x150x74	124x124	24 V d.c.	7,4	47	34	UR; cULus; cCSAus
FF12D24UN4	150x150x73	124x124	24 V d.c.	23	107	69	-
FF12D24UNR	150x150x73	124x124	24 V d.c.	7,4	64	46	UR; cULus; cCSAus
FF12D48UN	150x150x74	124x124	48 V d.c.	8,6	47	34	UR; cULus; cCSAus
FF12D48UNR	150x150x73	124x124	48 V d.c.	8,6	64	46	UR; cULus; cCSAus
FF13PA							
FF13PA115UF	204x204x96	177x177	115 V a.c.	19/18	100/110	64/76	cURus; cULus; cCSAus
FF13PA115UFR	204x204x96	177x177	115 V a.c.	18/18	100/110	70/84	cURus; cULus; cCSAus
FF13PA115UN	204x204x96	177x177	115 V a.c.	16/15	110/130	85/102	cURus; cULus; cCSAus
FF13PA230UF	204x204x96	177x177	230 V a.c.	18/18	100/110	64/76	cURus; cULus; cCSAus
FF13PA230UFR	204x204x96	177x177	230 V a.c.	18/18	100/110	70/84	cURus; cULus; cCSAus
FF13PA230UN	204x204x96	177x177	230 V a.c.	19/17	110/130	85/102	cURus; cULus; cCSAus
FF13PA230UNR	204x204x96	177x177	230 V a.c.	19/18	110/135	90/102	cURus; cULus; cCSAus
FF13PD							
FF13PD24UN	204x204x95	177x177	24 V d.c.	8,2	100	76	UR; cULus; cCSAus
FF13PD24UNR	204x204x95	177x177	24 V d.c.	8,5	113	86	UR; cULus; cCSAus
FF15A							
FF15A115UF	250x250x125	223x223	115 V a.c.	31/31	230/270	159/190	cURus; cULus; cCSAus
FF15A115UFR	250x250x125	223x223	115 V a.c.	31/31	245/290	160/199	cURus; cULus; cCSAus
FF15A115UN2	250x250x113	223x223	115 V a.c.	39/41	230/270	178/213	cURus; cULus; cCSAus
FF15A115UNR2	250x250x112	223x223	115 V a.c.	39/41	238/283	184/222	cURus; cULus; cCSAus
FF15A230UF	250x250x125	223x223	230 V a.c.	32/36	230/270	159/190	cURus; cULus; cCSAus
FF15A230UFR	250x250x125	223x223	230 V a.c.	32/36	245/290	160/199	cURus; cULus; cCSAus
FF15A230UN2	250x250x113	223x223	230 V a.c.	42/45	230/272	178/213	cURus; cULus; cCSAus
FF15A230UNR2	250x250x112	223x223	230 V a.c.	42/45	238/283	184/222	cURus; cULus; cCSAus
FF15D							
FF15D24UF	250x250x126	223x223	24 V d.c.	31	275	196	cURus; cULus; cCSAus
FF15D24UFR	250x250x125	223x223	24 V d.c.	31	295	210	cURus; cULus; cCSAus
FF15D24UN	250x250x125	223x223	24 V d.c.	17	245	180	UR; cULus; cCSAus
FF15D24UNR	250x250x125	223x223	24 V d.c.	17	285	210	UR; cULus; cCSAus
FF15D48UF	250x250x126	223x223	48 V d.c.	43	295	196	-
FF15D48UFR	250x250x125	223x223	48 V d.c.	43	310	210	-
FF15MA							
FF15MA115UF	250x250x112	223x223	115 V a.c.	16/15	130/145	92/106	-
FF15MA115UFR	250x250x112	223x223	115 V a.c.	16/15	140/155	112/126	-
FF15MA230UF	250x250x112	223x223	230 V a.c.	21/20	130/145	92/106	-
FF15MA230UFR	250x250x111	223x223	230 V a.c.	21/20	140/155	112/126	-
FF15PA							
FF15PA115UF	250x250x112	223x223	115 V a.c.	17/16	105/120	90/103	cURus; cULus; cCSAus
FF15PA115UFR	250x250x112	223x223	115 V a.c.	17/16	110/120	92/105	cURus; cULus; cCSAus
FF15PA230UF	250x250x112	223x223	230 V a.c.	18/17	105/120	90/103	cURus; cULus; cCSAus
FF15PA230UFR	250x250x112	223x223	230 V a.c.	18/17	110/120	92/105	cURus; cULus; cCSAus
FF15PA230UN	250x250x112	223x223	230 V a.c.	19/17	125/145	110/128	cURus; cULus; cCSAus

Model	Dimensions	Cut-Out	Rated Voltage	Rated Power	Max Airflow	Airflow with Exhaust Filter	Approvals
	mm	mm	V	W	m³/h	m³/h	
FF15PD							
FF15PD24UN	250x250x112	223x223	24 V d.c.	7,6	140	105	UR; cULus; cCSAus
FF15PD24UNR	250x250x112	223x223	24 V d.c.	7,6	150	124	UR; cULus; cCSAus
FF15PD48UN	250x250x112	223x223	48 V d.c.	8,6	140	105	UR; cULus; cCSAus
FF15PD48UNR	250x250x112	223x223	48 V d.c.	8,6	150	124	UR; cULus; cCSAus
FF20A							
FF20A115UE	325x325x161	291x291	115 V a.c.	100/129	445/490	320/350	-
FF20A115UE1	325x325x161	291x291	115 V a.c.	74/83	445/485	320/350	cURus; cULus; cCSAus
FF20A115UER	325x325x160	291x291	115 V a.c.	101/129	530/577	380/420	-
FF20A115UER1	325x325x161	291x291	115 V a.c.	74/83	530/575	380/420	cURus; cULus; cCSAus
FF20A230UE	325x325x161	291x291	230 V a.c.	92/116	460/510	325/360	-
FF20A230UE1	325x325x161	291x291	230 V a.c.	70/85	455/503	325/360	cURus; cULus; cCSAus
FF20A230UER	325x325x161	291x291	230 V a.c.	92/116	540/595	380/425	-
FF20A230UER1	325x325x161	291x291	230 V a.c.	70/85	540/590	380/420	cURus; cULus; cCSAus
FF20A400TUE	325x325x161	291x291	400 V a.c. 3 ~	99/124	537/632	361/410	-
FF20GA							
FF20GA115UE	325x325x159	291x291	115 V a.c.	143/177	708/775	505/550	-
FF20GA115UE1	325x325x159	291x291	115 V a.c.	110/156	675/738	495/520	cURus; cULus; cCSAus
FF20GA115UEA1	325x325x159	291x291	115 V a.c.	110/156	893/960	577/606	cURus; cULus; cCSAus
FF20GA115UER	325x325x159	291x291	115 V a.c.	124/192	760/845	580/620	-
FF20GA115UER1	325x325x159	291x291	115 V a.c.	102/145	760/850	570/630	cURus; cULus; cCSAus
FF20GA230UE	325x325x159	291x291	230 V a.c.	155/194	705/790	510/560	-
FF20GA230UE1	325x325x159	291x291	230 V a.c.	120/158	680/765	495/550	cURus; cULus; cCSAus
FF20GA230UEA	325x325x159	291x291	230 V a.c.	158/198	850/960	580/640	-
FF20GA230UEA1	325x325x159	291x291	230 V a.c.	120/158	895/998	573/650	cURus; cULus; cCSAus
FF20GA230UER	325x325x159	291x291	230 V a.c.	170/208	773/870	590/650	-
FF20GA230UER1	325x325x159	291x291	230 V a.c.	120/157	760/860	590/650	cURus; cULus; cCSAus
FF20GA400TUE	325x325x161	291x291	400 V a.c. 3 ~	137	587	397	-
FF20PA							
FF20PA115UF	325x325x164	291x291	115 V a.c.	45/45	310/350	270/295	cURus; cULus
FF20PA115UFR	325x325x164	291x291	115 V a.c.	45/45	339/374	292/324	cURus; cULus
FF20PA230UF	325x325x164	291x291	230 V a.c.	45/45	315/345	270/290	cURus; cULus
FF20PA230UFR	325x325x164	291x291	230 V a.c.	45/45	334/367	294/317	cURus; cULus



FF series filter fans IP5

- Protection from strong water jets and solid foreign bodies
- Tool-less assembly system with clips
- Plate thickness: FF08 from 1 to 2mm; FF12, FF13 from 1.3 to 3.2mm; FF15, FF20 from 1.3 to 3.7mm (up to 4mm with cut-out max tolerance)
- Quick electrical connection by screwless terminal block
- Standard colour RAL 7035, other colours available on request, subjects to quantity
- R version (airflow from inside to outside the enclosure)
- Frequency: 50/60Hz



Model	Dimensions	Cut-Out	Rated Voltage	Rated Power	Max Airflow	Airflow with Exhaust Filter	Approvals
	mm	mm	V	W	m³/h	m³/h	
FF12A5							
FF12A115UF5	150x150x74	124x124	115 V a.c.	16/15	33/39	23/27	cURus; cULus; cCSAus
FF12A230UF5	150x150x74	124x124	230 V a.c.	18/17	33/39	23/27	cURus; cULus; cCSAus
FF12A230UFR5	150x150x74	124x124	230 V a.c.	18/17	37/43	27/32	cURus; cULus; cCSAus
FF12A230UN5	150x150x73	124x124	230 V a.c.	18/16	50/59	32/38	cURus; cULus; cCSAus
FF12D5							
FF12D24UN5	150x150x73	124x124	24 V d.c.	7,4	35	24	UR; cULus; cCSAus
FF13PA5							
FF13PA115UN5	204x204x96	177x177	115 V a.c.	16/15	90/110	62/75	cURus; cULus; cCSAus
FF13PA230UF5	204x204x96	177x177	230 V a.c.	18/18	75/87	46/54	cURus; cULus; cCSAus
FF13PA230UN5	204x204x96	177x177	230 V a.c.	19/17	90/110	62/75	cURus; cULus; cCSAus
FF13PD5							
FF13PD24UN5	204x204x92	177x177	24 V d.c.	8,2	85	52	UR; cULus; cCSAus
FF15A5							
FF15A115UF5	250x250x125	223x223	115 V a.c.	31/31	160/195	117/138	cURus; cULus; cCSAus
FF15A230UF5	250x250x125	223x223	230 V a.c.	32/36	160/195	117/138	cURus; cULus; cCSAus
FF15A230UFR5	250x250x125	223x223	230 V a.c.	32/36	165/200	130/159	cURus; cULus; cCSAus
FF15D5							
FF15D24UF5	250x250x126	223x223	24 V d.c.	31	230	158	cURus; cULus; cCSAus
FF15D24UN5	250x250x125	223x223	24 V d.c.	17	205	141	UR; cULus; cCSAus
FF15D48UF5	250x250x126	223x223	48 V d.c.	42	215	152	-
FF15PA5							
FF15PA115UF5	250x250x112	223x223	115 V a.c.	17/16	96/110	68/82	cURus; cULus; cCSAus
FF15PA230UF5	250x250x112	223x223	230 V a.c.	18/17	96/110	68/82	cURus; cULus; cCSAus
FF15PA230UFR5	250x250x112	223x223	230 V a.c.	18/17	98/110	76/87	cURus; cULus; cCSAus
FF20A5							
FF20A230UE5	325x325x161	291x291	230 V a.c.	79/99	405/460	275/310	-
FF20A230UE51	325x325x161	291x291	230 V a.c.	70/85	360/400	255/290	cURus; cULus; cCSAus
FF20A230UER5	325x325x161	291x291	230 V a.c.	79/96	460/515	330/365	-



FF series filter fans Type 3R

- UV resistant
- Weatherproof plastic construction, ideal for outdoor applications
- Tool-less assembly system with clips
- Plate thickness: FF08 from 1 to 2mm; FF12, FF13 from 1.3mm to 3.2mm; FF20 from 1.3 to 3.7mm (up to 4mm with cut-out max tolerance)
- Quick electrical connections by screwless terminal block
- Standard colour RAL 9005
- Standard protection ratings: Type 3R and IP55 (IP54 for FF08 series)
- Frequency: 50/60 hz



Model	Dimensions	Cut-Out	Rated Voltage	Rated Power	Max Airflow	Airflow with Exhaust Filter	Approvals
	mm	mm	V	W	m³/h	m³/h	
FF08A3							
FF08A115NN3	107x107x67	91,5x91,5	115 V a.c.	9/7	12/15	9/11.5	cURus; cULus
FF08A230NN3	107x107x67	91,5x91,5	230 V a.c.	10/8	12/15	9/11.5	cURus; cULus
FF08D3							
FF08D12NN3	107x107x54	91,5x91,5	12 V d.c.	2	16	11	cURus; cULus
FF08D24NN3	107x107x54	91,5x91,5	24 V d.c.	2	16	11	cURus; cULus
FF08GA3							
FF08GA115NF3	107x107x80	92,5x92,5	115 V a.c.	12/10	21/26	16/18	cURus; cULus
FF08GA230NF3	107x107x80	92,5x92,5	230 V a.c.	12/11	21/26	16/18	cURus; cULus
FF08GD3							
FF08GD24NN3	107x107x77	92,5x92,5	24 V d.c.	15	50	36	cURus; cULus
FF12A53							
FF12A115NF53	150x150x73	125x125	115 V a.c.	16/15	33/39	22/25	cURus; cULus
FF12A115NN53	150x150x73	125x125	115 V a.c.	19/17	50/59	32/38	cURus; cULus
FF12A230NF53	150x150x74	125x125	230 V a.c.	18/17	33/39	22/25	cURus; cULus
FF12A230NN53	150x150x73	125x125	230 V a.c.	18/16	50/59	32/38	cURus; cULus
FF12D53							
FF12D24NN53	150x150x73	125x125	24 V d.c.	7,4	35	24	UR; cULus
FF12D48NN53	150x150x73	125x125	48 V d.c.	8,6	35	24	UR; cULus
FF13PA53							
FF13PA115NF53	204x204x96	177x177	115 V a.c.	19/18	75/87	46/54	cURus; cULus
FF13PA115NN53	204x204x96	177x177	115 V a.c.	16/15	90/110	62/75	cURus; cULus
FF13PA230NF53	204x204x96	177x177	230 V a.c.	18/18	75/87	46/54	cURus; cULus
FF13PA230NN53	204x204x96	177x177	230 V a.c.	19/17	90/110	62/75	cURus; cULus
FF13PD53							
FF13PD24NN53	204x204x95	177x177	24 V d.c.	8,2	85	52	UR; cULus
FF15A53							
FF15A115NF53	250x250x125	223x223	115 V a.c.	31/31	160/195	115/140	cURus; cULus
FF15A115NN532	250x250x112	223x223	115 V a.c.	39/41	187/225	118/142	cURus; cULus
FF15A230NF53	250x250x124	223x223	230 V a.c.	32/36	160/195	118/140	cURus; cULus
FF15A230NN532	250x250x113	223x223	230 V a.c.	42/45	187/225	118/142	cURus; cULus
FF15D53							
FF15D24NF53	250x250x125	223x223	24 V d.c.	31	230	158	cURus; cULus
FF15D24NN53	250x250x125	223x223	24 V d.c.	17	205	141	UR; cULus
FF15PA53							
FF15PA115NF53	250x250x112	223x223	115 V a.c.	17/16	96/110	68/82	cURus; cULus
FF15PA230NF53	250x250x112	223x223	230 V a.c.	18/17	96/110	68/82	cURus; cULus

Model	Dimensions	Cut-Out	Rated Voltage	Rated Power	Max Airflow	Airflow with Exhaust Filter	Approvals
	mm	mm	V	W	m³/h	m³/h	
FF15PD53							
FF15PD24NN53	250x250x112	223x223	24 V d.c.	7,6	110	81	UR; cULus
FF15PD48NN53	250x250x112	223x223	48 V d.c.	8,6	110	81	UR; cULus
FF20A53							
FF20A115NE531	325x325x161	291x291	115 V a.c.	74/83	338/378	240/275	cURus; cULus
FF20A230NE531	325x325x161	291x291	230 V a.c.	70/85	360/400	255/288	cURus; cULus
FF20GA31							
FF20GA115NE31	325x325x159	291x291	115 V a.c.	110/156	675/738	488/510	cURus; cULus
FF20GA230NE31	325x325x159	291x291	230 V a.c.	120/158	680/765	500/550	cURus; cULus



GF series exhaust filter

- Mounting system with jacks for plastic or plate enclosures
- Plate thickness: up to 8mm and by cutting the jacks up to 16mm
- Standard colour RAL 7035, other colours available on request
- IP54 protection degree



Model	Dimensions mm	Cut-Out mm
GF12KUG	150x150x31	125x125
GF15KUG	250x250x32	223x223
GF20KUG	325x325x33	290x290



GF series filter fan

- Mounting system with jacks for plastic or plate enclosures
- Plate thickness: up to 8mm and by cutting the jacks up to 16mm
- Standard colour RAL 7035, other colours available on request
- IP54 protection degree
- R version (airflow from inside to outside the enclosure)
- Frequency: 50/60Hz



Model	Dimensions mm	Cut-Out mm	Rated Voltage V	Rated Power W	Max Airflow m³/h	Airflow with Exhaust Filter m³/h
GF12K						
GF12KU230BE	150x150x76	125x125	230 V a.c.	17/16	47/53	32/37
GF12KU230BER	150x150x76	125x125	230 V a.c.	17/16	41/46	32/36
GF12KD						
GF12KUD24B	150x150x76	125x125	24 V d.c.	7	46	33
GF15KP						
GF15KPU230BE	250x250x110	223x223	230 V a.c.	18/18	116/130	96/108
GF15K						
GF15KU115BE	250x250x118	223x223	115 V a.c.	32/35	220/265	150/180
GF15KU230BE	250x250x118	223x223	230 V a.c.	32/34	225/265	150/185
GF15KU230BER	250x250x123	223x223	230 V a.c.	32/35	245/285	160/185
GF20KG						
GF20KGU230B	325x325x148	290x290	230 V a.c.	159/125	580/670	420/470
GF20K						
GF20KU230BE	325x325x159	290x290	230 V a.c.	76/92	470/530	330/380



TP series roof exhaust units without fan

- Plastic structure with aluminium top
- Plate thickness: any
- Available in 3 protection degrees: IP24, IP54 e IP55
- Standard colour RAL 7035, others colours available on request, subject to quantity



Model	Dimensions mm	IP Protection Degree	Approvals
TP19U1	324x324x94	IP24	cURus; cULus; cCSAus
TP19U541	324x324x94	IP54	cURus; cULus; cCSAus
TP19U551	324x324x94	IP55	cURus; cULus; cCSAus



TP series AC roof exhaust units

- Plastic structure with aluminium top
- Plate thickness: any
- Available in 4 protection degrees: IP24, IP44, IP54 e IP55
- Standard colour RAL 7035, other colours available on request
- Frequency: 50/60 hz



Model	Dimensions mm	Rated Voltage V	Rated Power W	Max Airflow m³/h	Airflow with Exhaust Filter m³/h	IP Protection Degree	Approvals
TP19B							
TP19U115B	324x324x94	115 V a.c.	62/75	500/575	445/505	IP24	-
TP19U115B1	324x324x94	115 V a.c.	/97	/575	/505	IP24	cURus; cULus; cCSAus
TP19U115B54	324x324x94	115 V a.c.	66/74	420/490	380/440	IP54	-
TP19U115B541	324x324x94	115 V a.c.	/97	/490	/440	IP54	cURus; cULus; cCSAus
TP19U115B55	324x324x94	115 V a.c.	66/74	420/490	380/440	IP55	-
TP19U115B551	324x324x94	115 V a.c.	/97	/490	/440	IP55	cURus; cULus; cCSAus
TP19U230B	324x324x94	230 V a.c.	67/83	500/575	445/505	IP24	-
TP19U230B1	324x324x94	230 V a.c.	70/81	500/575	445/505	IP24	cURus; cULus; cCSAus
TP19U230B44	324x324x94	230 V a.c.	69/81	485/560	430/495	IP44	-
TP19U230B54	324x324x94	230 V a.c.	70/83	420/490	380/440	IP54	-
TP19U230B541	324x324x94	230 V a.c.	70/81	420/490	380/440	IP54	cURus; cULus; cCSAus
TP19U230B55	324x324x94	230 V a.c.	70/83	420/490	380/440	IP55	-
TP19U230B551	324x324x94	230 V a.c.	70/81	420/490	380/440	IP55	cURus; cULus; cCSAus



TP series roof exhaust units in CC

- Plastic structure with aluminium top
- Plate thickness: any
- Standard colour RAL 7035, other colours on request, subject to quantity
- Locked rotor protection
- Speed sensor output (open collector)
- PWM or 0-10 Vd.c signal input for speed adjustment



Model	Dimensions	Rated Voltage	Rated Power	Max Airflow	Airflow with Exhaust Filter	IP Protection Degree
	mm	V	W	m³/h	m³/h	
TP19DB						
TP19UD24B	324x324x120	24 V d.c.	95	613	540	IP24
TP19UD24B44	324x324x120	24 V d.c.	93	600	530	IP44
TP19UD24B54	324x324x120	24 V d.c.	92	543	482	IP54
TP19UD24B55	324x324x120	24 V d.c.	92	543	455	IP55
TP19UD48B	324x324x120	48 V d.c.	96	613	565	IP24
TP19UD48B44	324x324x120	48 V d.c.	95	600	535	IP44
TP19UD48B54	324x324x120	48 V d.c.	93	555	500	IP54
TP19UD48B55	324x324x120	48 V d.c.	93	555	482	IP55



T series roof exhaust unit without fan

- Metal structure
- Plate thickness: any
- IP23 protection degree
- Standard colour RAL 7035 and RAL 7032



Model	Dimensions	IP Protection Degree
	mm	
T19UK	375x295x119	IP23



T series roof exhaust units

- Metal structure
- Plate thickness: any
- IP23 protection degree
- Standard colour RAL 7035 e RAL 7032
- Frequency: 50/60 Hz



Model	Dimensions	Rated Voltage	Rated Power	Max Airflow	Airflow with Exhaust Filter	IP Protection Degree
	mm	V	W	m³/h	m³/h	
T19B						
T19R115B	375x295x119	115 V a.c.	58/71	550/590	487/525	IP23
T19R230B	375x295x119	230 V a.c.	62/78	550/590	487/525	IP23
T19U115B	375x295x119	115 V a.c.	58/71	550/590	487/525	IP23
T19U230B	375x295x119	230 V a.c.	62/78	550/590	487/525	IP23
T22B						
T22R115B	375x295x119	115 V a.c.	130/170	800/850	660/700	IP23

Model	Dimensions	Rated Voltage	Rated Power	Max Airflow	Airflow with Exhaust Filter	IP Protection Degree
	mm	V	W	m³/h	m³/h	
T22R230B	375x295x119	230 V a.c.	125/161	800/850	660/700	IP23
T22U115B	375x295x119	115 V a.c.	130/170	800/850	660/700	IP23
T22U230B	375x295x119	230 V a.c.	125/161	640/645	440/450	IP23



Accessories - Type 4X hose-proof protection hood

- Particularly suitable for outdoor applications or in food&beverage industry
- Suitable for all sizes of FF e GF series
- AISI 304 stainless steel brushed finish
- Slide mounting system on brackets
- IP56/Type 4X protection degree when used with FF filter fans
- UL approved only if used in combination with FF filter fans



Model	Suitable for filters	Approvals
SSC-08A	FF08	cURus; cULus
SSC-12A	FF12; GF12	cURus; cULus
SSC-13A	FF13	cURus; cULus
SSC-15A	FF15; GF15	cURus; cULus
SSC-20A	FF20; GF20	cURus; cULus



Accessories - Hose-proof protection hood

- Particularly suitable for outdoors applications
- Suitable for all sizes of FF e GF series
- AISI 304 stainless steel cover of 1mm thickness
- Slide mounting system on brackets
- IP56 protection degree in combination with a FF filter fans



Model	Suitable for filters
SSC-08	FF08
SSC-12	FF12; GF12
SSC-13	FF13
SSC-15	FF15; GF15
SSC-20	FF20; GF20



Accessories - Adapters

- Allow fan filter installation in a semi built-in position in the electric cabinet, reducing the internal dimensions
- Available for FF and GF series in 150x150mm, 204x204mm and 325x325mm sizes
- Standard colour RAL 7035 and RAL 7032



Model	Suitable for filters
FPFA12-7032G	FF12; GF12
FPFA12-7035G	FF12; GF12
FPFA12-9005G	FF12; GF12
FPFA15-7032G	FF15; GF15
FPFA15-7035G	FF15; GF15
FPFA20-7011G	FF20; GF20
FPFA20-7032G	FF20; GF20
FPFA20-7035G	FF20; GF20



Accessories - Filter media

- Filter media can be cleaned, up to 10 times, by careful washing, blowing dry and lightly beating
- Available for FF, FPF and GF filter fans in all sizes and TP roof exhaust units
- G4 not available for FF08 and FPF08 models
- -K versions: 6 pieces kit



Model	Suitable for filters	Filter Class
M08FPFK	FF08; FPF08	ISO coarse 55%; G3
M117-TP19	TP19	ISO coarse 30%; G2
M12FPF5K	FF12; FPF12	ISO coarse 75%; G4
M12FPFK	FF12; FPF12	ISO coarse 55%; G3
M12GFK	GF12	ISO coarse 55%; G3
M13FPF5K	FF13; FPF13	ISO coarse 75%; G4
M13FPFK	FF13; FPF13	ISO coarse 55%; G3
M15FPF5K	FF15; FPF15	ISO coarse 75%; G4
M15FPFK	FF15; FPF15	ISO coarse 55%; G3
M15GFK	GF15	ISO coarse 55%; G3
M20FPF5K	FF20; FPF20	ISO coarse 75%; G4
M20FPFK	FF20; FPF20	ISO coarse 55%; G3
M20GFK	GF20	ISO coarse 55%; G3

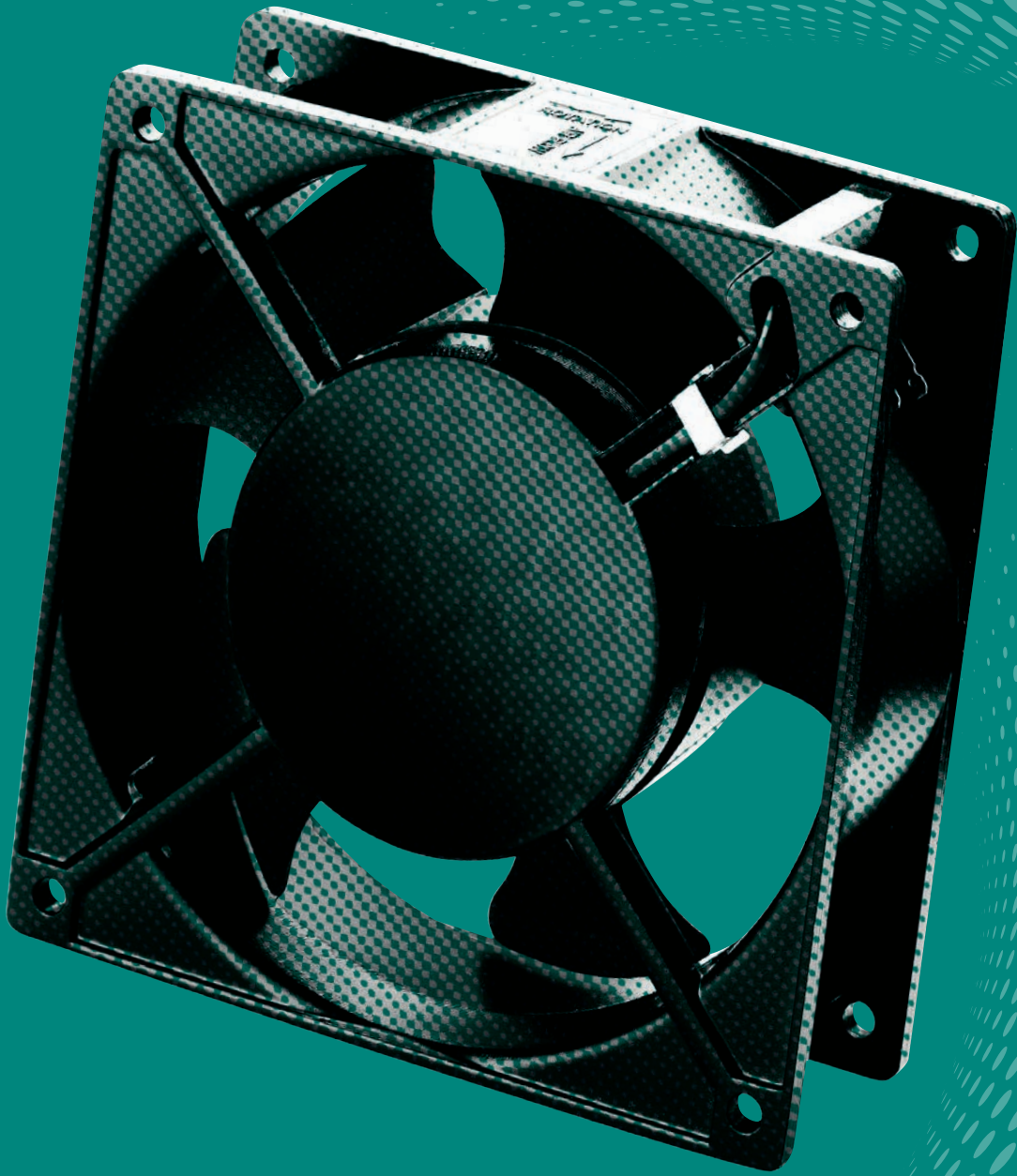

Localized cooling solutions

Axial and centrifugal fans provide a solution for the cooling electrical and electronic equipment particularly sensitive to temperature and disposing of the heat produced during their operation.

Compact and high performing, they adapt to various industrial applications.

ESMERIS
frame fans

■ STANDARD FRAME FANS COSTECH

Axial fans, characterized by large airflow rates and low noise, are ideal for forced ventilation and heat dispersion inside electrical and electronic equipment, especially in areas with restricted spaces. Centrifugal fans, on the other hand, produce a more concentrated airflow and are used in applications requiring high pressure.



MOTOR TYPE

AC shaded pole or capacitor, or alternatively with brushless DC motor

ELECTRICAL CONNECTION

Wires or terminal

FAN DESIGN

With or without external casing

SUPPORT SYSTEM

Long-life ball bearing, quiet operation sleeve bearing or hypro

ENERGY EFFICIENCY

EC green technology for high performance

DC SIGNALS

Alarm or speed sensor provided by a separate wire

APPROVALS



■ Details that make the difference



Frameless version



Blower



DC signal

DC FANS WITH THIRD WIRE

DC FANS WITH SPEED SIGNAL

The integrated electronic sensor outputs a square-wave signal proportional to the fan speed. The signal is transmitted via a third wire (open collector).

DC FANS WITH ALARM SIGNAL

It is used to detect whether the fan is running or stopped. The third wire (open collector) transmits a continuous high or low signal according to the fan type.

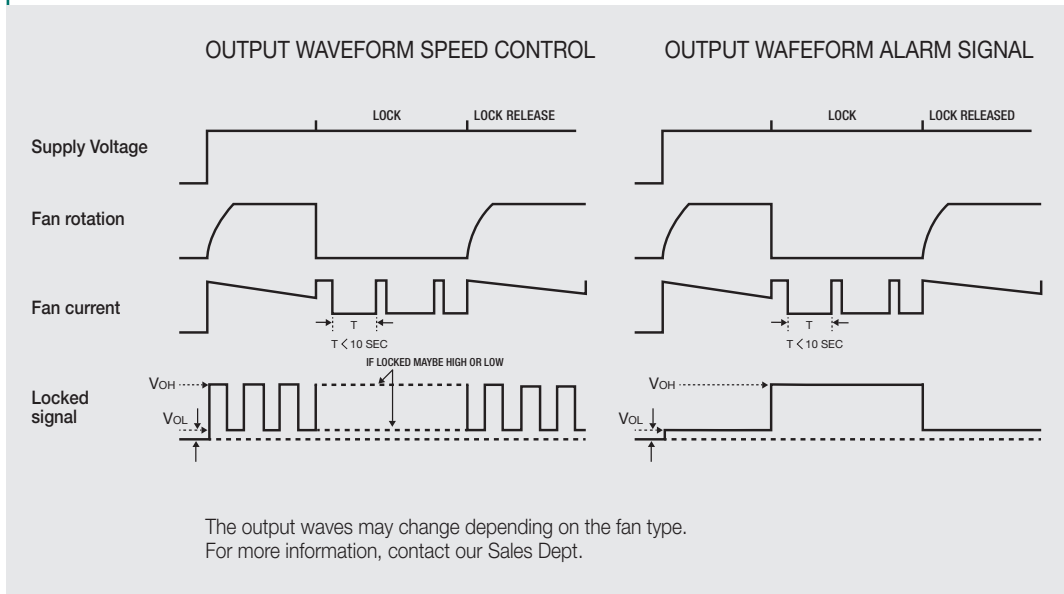
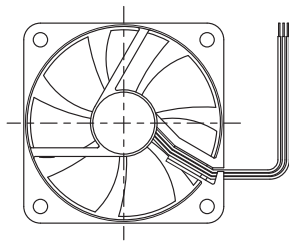

ELECTRICAL DIAGRAM (OPEN COLLECTOR)

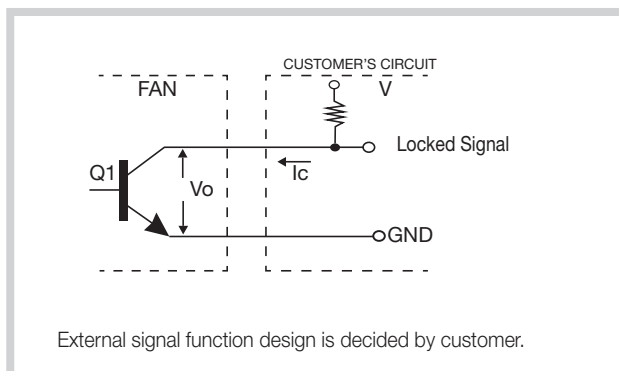

■ EC FANS



EC stands for Electronically Commutated and combines AC and DC voltages to offer the best of both technologies. The EC fan motor is a permanent magnet brushless motor, in which an electronic circuit, integrated into the motor, allows connection to the AC mains. The great advantage of EC fans, compared to shielded pole fans, is in their high energy efficiency.

The integrated electronics (PCB) aboard the motor (stator) manages the operating parameters and transforms the voltage from alternating to direct current.



ADVANTAGES

- Energy saving: lower power consumption and higher efficiency compared to an equivalent AC fan
- Wide operating range 230 VAC: 140~264 VAC; 115 VAC: 80~132 VAC
- Low-temperature motor and longer life compared to an equivalent AC device
- Simplicity: electronics and electrical conversion fully integrated in the motor
- High performance: better pressure and airflow values compared to an equivalent AC fan

■ SPECIAL FRAME FANS

A complete range of AC/DC fans designed to operate in hostile environmental conditions: fans protected from very fine dust or splashes of water (IP55) or capable of tolerating high temperatures up to 90°C, thanks to the special metal structure. These special solutions ensure safety and operational reliability and extend the life of the equipment.



IP55
Ideal for indoor or outdoor use in harsh industrial environments



ALL METAL
Robust metal fan blades for good corrosion resistance



HIGH TEMPERATURE RESISTANT
Capable of running continuously at 90°C

Model numbering system for STANDARD FRAME FANS COSTECH

description	A	12	B	23	H	T	B	A	00	description
MOTOR TYPE A = a.c. shaded pole motor C = a.c. capacitor run induction motor D = d.c. brushless										OPTIONS 00 = no option A = alarm output S = speed signal output M = digital PWM speed control T = for high temperature ambient F = motor IP55 protected G = motor IP58 protected W** = wires lenght out of standard Q** = special version
CASING SIZE (mm) 01 = 15x15 axial fan 20 = 20x20 axial fan 02 = 25x25 axial fan 03 = 30x30 axial fan 35 = 35x35 axial fan 04 = 40x40 axial fan 45 = 45x45 axial fan 50 = 50x50 axial fan 06 = 60x60 axial fan 07 = 70x70 axial fan 08 = 80x80 axial fan 09 = 92x92 axial fan 12 = 120x120 axial fan 13 = 127x127 axial fan 17 = 172x150 axial fan 18 = ø 172 axial fan 22 = 218x218 axial fan 25 = 280x280 axial fan C1 = 120x120 blower C6 = 75x75 blower										DESIGN BEARING TYPE B = shielded ball S = sleeve H = hypro
CASING THICKNESS (mm) N = 6.5 E = 10 F = 15 D = 20 A = 25 G = 30-32 B = 38 standard flow R = 38 reverse flow C = 50-52 M = 55 S = 83 W = without casing, standard flow Z = without casing, reverse flow										CONNECTION K = terminal block T = flat terminals 110 series (2.8x0.5 mm) W = lead wires
										SPEED E = extra low M = medium U = ultra high V = very low H = high I = hyper high L = low S = super high
										RATED VOLTAGE 01 = 5 V d.c. 12 = 115 V a.c. 04 = 12 V d.c. 23 = 230 V a.c. 05 = 24 V d.c. / V a.c. 40 = 400 V a.c. 3~ 07 = 48 V d.c.

Model numbering system for STANDARD FRAME FANS COSTECH (NEW)

description	A 12 B 23 H T B A 5 0 - R F T 0 - W00	description
FAN TYPE A = axial a.c. shaded pole B = blower d.c. brushless C = axial a.c. capacitor run induction motor D = axial d.c. brushless E = axial EC fan J = blower a.c. capacitor run induction motor R = blower a.c.		CUSTOMIZATION W** = wire lenght not standard Q** = special version
CASING SIZE (mm) 01 = 15x15 08 = 80x80 20 = 20x20 09 = 92x92 02 = 25x25 97 = 97x97 or 97x94 (blower) 03 = 30x30 12 = 120x120 35 = 35x35 13 = 127x127 04 = 40x40 17 = 172x150 45 = 45x45 18 = ø 172 50 = 50x50 22 = 218x218 06 = 60x60 23 = 225x225 07 = 70x70 mm 25 = 280x280		FREE PROGRESSIVE DIGIT () = standard 0-9 = progressive
CASING THICKNESS (mm) N = 6.5 G = 30-32 E = 10 B = 38 F = 15 C = 50-52 D = 20 M = 55 A = 25 S = 78-80-83 J = 28 W = without casing		HIGH TEMPERATURE () = standard temperature T = high temperature
RATED VOLTAGE 01 = 5 V d.c. 12 = 115 V a.c. 04 = 12 V d.c. 23 = 230 V a.c. 05 = 24 V d.c. / V a.c. 30 = 115-230 V a.c. 07 = 48 V d.c. 40 = 400 V a.c. 3~		IP PROTECTION () = IP20 G = IP58 F = IP55 coated K = IP68 P = IP55 parylene
SPEED E = extra low M = medium U = ultra high V = very low H = high I = hyper high L = low S = super high		AIR FLOW DIRECTION () = standard flow with casing R = reverse flow with casing W = standard flow without casing Z = reverse flow without casing
CONNECTION K = terminal block T = flat terminal W = wires		OPTIONS 0 = by impedance 1 = by IC 2 = by IC with alarm (RD) 3 = by IC with speed sensor (FG) 4 = by IC variable speed sensor (VS) 6 = by transistor with speed sensor (FG) 7 = two speed 8 = VS + FG 9 = PWM control A = VS + RD B = PWM + FG C = RD + FG D = thermally protected F = PWM + RD
BEARING TYPE B = ball S = sleeve H = hypro		BLADES NUMBER 5 = 5 C = 15 7 = 7 D = 17 9 = 9 E = 19 A = 11 F = 21 B = 13 0 = blower blade shape
		DESIGN



AC axial frame fans - Costech

- Shielded pole motor
- Wire (W) or terminal (T)
- Impedance or thermal motor protection
- Support system: ball or sleeve bearing
- Frameless version (A12W e A12Z models)



Model	Dimensions	Rated Voltage	Max Airflow	Noise	Bearing	Approvals
	mm	V	m³/h	dB(A)		
A06						
A06G12HWBF00	60x60x30	115 V a.c.	14/17	27/28	Ball Bearing	cURus
A06G23HWBF00	60x60x30	230 V a.c.	14/17	27/28	Ball Bearing	cURus
A08						
A08A23HWBF00	80x80x25	230 V a.c.	32/39	32/35	Ball Bearing	UR
A08A23HWSF00	80x80x25	230 V a.c.	32/39	32/35	Sleeve Bearing	UR
A08B23HWBF00	80x80x38	230 V a.c.	41/51	32/36	Ball Bearing	UR
A08B23HWSF00	80x80x38	230 V a.c.	41/51	32/36	Sleeve Bearing	UR
A09						
A09A23HTBF00	92x92x25	230 V a.c.	56/68	32/36	Ball Bearing	UR
A09A23HTSF00	92x92x25	230 V a.c.	56/68	32/36	Sleeve Bearing	UR
A12						
A12A23HTBF00	120x120x25	230 V a.c.	102/119	38/42	Ball Bearing	UR
A12A23HTSF00	120x120x25	230 V a.c.	109/127	38/42	Sleeve Bearing	UR
A12B05HTBW00	120x120x38	24 V a.c.	129/142	45/48	Ball Bearing	-
A12B05HTSW00	120x120x38	24 V a.c.	147/142	46/45	Sleeve Bearing	-
A12B12HTBW00	120x120x38	115 V a.c.	148/182	46/49	Ball Bearing	cURus; VDE
A12B12HTSW00	120x120x38	115 V a.c.	138/178	44/48	Sleeve Bearing	cURus; VDE
A12B12HWBW00	120x120x38	115 V a.c.	148/182	46/49	Ball Bearing	cURus; VDE
A12B12STSW00	120x120x38	115 V a.c.	165/182	47/50	Sleeve Bearing	cURus; VDE
A12B23ETSW00	120x120x38	230 V a.c.	83/82	29/28	Sleeve Bearing	VDE
A12B23HTBW00	120x120x38	230 V a.c.	139/182	46/49	Ball Bearing	cURus; VDE
A12B23HTSW00	120x120x38	230 V a.c.	138/178	44/48	Sleeve Bearing	cURus; VDE
A12B23HWBW00	120x120x38	230 V a.c.	148/182	46/49	Ball Bearing	cURus; VDE
A12B23LTSW00	120x120x38	230 V a.c.	115/104	41/37	Sleeve Bearing	cURus; VDE
A12B23MTBW00	120x120x38	230 V a.c.	133/143	43/45	Ball Bearing	cURus; VDE
A12B23STBW00	120x120x38	230 V a.c.	143/199	47/50	Ball Bearing	cURus; VDE
A12B23STSW00	120x120x38	230 V a.c.	141/182	47/50	Sleeve Bearing	cURus; VDE
A12B23SWBW00	120x120x38	230 V a.c.	143/199	47/50	Ball Bearing	cURus; VDE
A12W23HWBW00	113x113x38	230 V a.c.	148/182	46/49	Ball Bearing	cURus
A12Z23HWBW00	113x113x38	230 V a.c.	148/182	46/49	Ball Bearing	-
A13						
A13B12HTBF00	127x127x38	115 V a.c.	174/204	46/50	Ball Bearing	cURus
A13B23HTBF00	127x127x38	230 V a.c.	174/204	46/50	Ball Bearing	cURus
A17						
A17C12HWBF00	172x150x51	115 V a.c.	290/331	50/55	Ball Bearing	cURus
A17C23HWBF00	172x150x51	230 V a.c.	290/331	50/55	Ball Bearing	cURus
C17						
C17B12HTBF00	172x150x38	115 V a.c.	300/360	54/58	Ball Bearing	cURus
C17B23HTBF00	172x150x38	230 V a.c.	300/360	54/58	Ball Bearing	cURus
C17C23HTBF00	172x150x51	230 V a.c.	348/384	53/58	Ball Bearing	cURus

Model	Dimensions mm	Rated Voltage V	Max Airflow m³/h	Noise dB(A)	Bearing	Approvals
C18						
C18C12HTBF00	172x172x51	115 V a.c.	348/384	50/55	Ball Bearing	cURus
C18C23HTBF00	172x172x51	230 V a.c.	348/384	50/55	Ball Bearing	cURus
C22						
C22S12HKBD00	218x218x83	115 V a.c.	855/930	64,6/67,4	Ball Bearing	-
C22S23HKBD00	218x218x83	230 V a.c.	855/930	65/68	Ball Bearing	-
C22S23HKBU00	218x218x83	230 V a.c.	837/937	65/68	Ball Bearing	cURus
C22S40HKBD00	218x218x83	400 V a.c. 3 ~	970	61	Ball Bearing	-
C25						
C25S12HKBE00	280x280x80	115 V a.c.	1680/1920	64,6/67,4	Ball Bearing	-
C25S23HKBE00	280x280x80	230 V a.c.	1630/1865	67/70	Ball Bearing	-
C25S23HKBU00	280x280x80	230 V a.c.	1660/1835	67,8/72	Ball Bearing	cURus
C25S40HKBE00	280x280x80	400 V a.c. 3 ~	1540/1680	69/72	Ball Bearing	-



DC axial frame fans - Costech

- Brushless motor
- Wire connection
- Motor protection: impedance or I.C.
- Support system: ball, sleeve or hypro bearing
- Alarm or speed sensor output (optional)



Model	Dimensions mm	Rated Voltage V	Max Airflow m³/h	Noise dB(A)	Bearing	Approvals
D04						
D04D04HWBZ00	40x40x20	12 V d.c.	14	35,3	Ball Bearing	cURus
D04D05HWBZ00	40x40x20	24 V d.c.	15	36	Ball Bearing	cURus
D04E04HWHT00	40x40x10	12 V d.c.	11	26	Hypro Bearing	cURus
D04E05HWBT00	40x40x10	24 V d.c.	11	30,5	Ball Bearing	cURus
D04E05HWHT00	40x40x11	24 V d.c.	11	30.5	Hypro Bearing	cURus
D06						
D06A04HWBA00	60x60x25	12 V d.c.	40	33,1	Ball Bearing	cURus
D06A05HWBA00	60x60x25	24 V d.c.	40	33,1	Ball Bearing	cURus
D06F05HWBA91	60x60x16	24 V d.c.	31	35,5	Ball Bearing	-
D08						
D08A04HWSA00	80x80x25	12 V d.c.	68	33,4	Sleeve Bearing	cURus
D08A05HWBA00	80x80x25	24 V d.c.	68	33,4	Ball Bearing	UR
D08A05HWSA00	80x80x25	24 V d.c.	68	33,4	Sleeve Bearing	UR
D08A05SWHA71	80x80x25	24 V d.c.	80	44	Hypro Bearing	cURus
D08D04HWSA00	80x80x20	12 V d.c.	49	34	Sleeve Bearing	UR
D09						
D09A04HWSZ00	92x92x25	12 V d.c.	87	35,4	Sleeve Bearing	cURus
D09A04SWSZ00	92x92x25	12 V d.c.	105	42,2	Sleeve Bearing	cURus
D09A05HWBZ00	92x92x25	24 V d.c.	95	37,5	Ball Bearing	cURus
D09A05HWSZ00	92x92x25	24 V d.c.	87	35,4	Sleeve Bearing	cURus
D12						
D12A04SWSZ00	120x120x25	12 V d.c.	150	43,9	Sleeve Bearing	cURus
D12A05HWBZ00	120x120x25	24 V d.c.	134	39,3	Ball Bearing	cURus
D12A05HWSZ00	120x120x25	24 V d.c.	149	39,1	Sleeve Bearing	cURus
D12B04HWBZ00	120x120x38	12 V d.c.	179	46,7	Ball Bearing	UR

Model	Dimensions mm	Rated Voltage V	Max Airflow m³/h	Noise dB(A)	Bearing	Approvals
D12B05HWBZ00	120x120x38	24 V d.c.	179	46,7	Ball Bearing	cURus
D12B05HWSZ00	120x120x38	24 V d.c.	179	46,7	Sleeve Bearing	cURus
D12B05SWBZ00	120x120x38	24 V d.c.	204	48	Ball Bearing	cURus
D17						
D17C05HWBA00	172x150x51	24 V d.c.	450	58,8	Ball Bearing	cURus
D17C07HWBA00	172x150x51	48 V d.c.	450	58,8	Ball Bearing	cURus



EC axial frame fans - Costech

- EC green technology for high performances
- Brushless motors
- Wire connection
- Impedance protected motor
- Ball bearing system



Model	Dimensions mm	Rated Voltage V	Max Airflow m³/h	Noise dB(A)	Bearing
E08					
E08B12HWBL00	80x80x38	115 V a.c.	64/68,5	35/37	Ball Bearing
E08B23HWBL00	80x80x38	230 V a.c.	68/73	37/39	Ball Bearing
E12					
E12B23HWBL00	120x120x38	230 V a.c.	198/206	45/46,8	Ball Bearing
E12B23LWBL00	120x120x38	230 V a.c.	132/138	34/35,7	Ball Bearing
E12B23MWBL00	120x120x38	230 V a.c.	169/176	40/41,8	Ball Bearing



DC blowers

- Brushless motor
- Wire connection
- IC protected motor
- Support system: ball bearing



Model	Dimensions mm	Rated Voltage V	Max Airflow m³/h	Noise dB(A)	Bearing	Approvals
DC1G05MWBA01	120x120x31	24 V d.c.	48	49	Ball Bearing	cURus



IP55 AC fans

- Water jet resistant and dustproof
- Shaded pole motor
- Wire (W) or terminal (T) connection
- Motor protection: impedance or thermal
- Support system: ball or sleeve bearing
- Frameless versions (A12W e A12Z models)



Model	Dimensions mm	Rated Voltage V	Max Airflow m³/h	Noise dB(A)	Bearing	Approvals
A08B23HWBFF0	80x80x38	230 V a.c.	41/51	32/36	Ball Bearing	-
A12B05HTBWF0	120x120x38	24 V a.c.	129/142	45/48	Ball Bearing	-
A12B23HWBWF0	120x120x38	230 V a.c.	148/182	46/49	Ball Bearing	-
A12W23HWBWF0	113x113x38	230 V a.c.	150/180	46/49	Ball Bearing	-
A12Z23HWBWF0	113x113x38	230 V a.c.	148/182	46/49	Ball Bearing	-
A17M23SWBMF0	172x150x55	230 V a.c.	332/391	49/53	Ball Bearing	cURus



IP55 DC fans

- Water jet resistant and dustproof
- Brushless motor
- Wire connection
- Motor protection: impedance or IC
- Ball bearing system



Model	Dimensions mm	Rated Voltage V	Max Airflow m³/h	Noise dB(A)	Bearing	Approvals
D08A04HWBAF0	80x80x25	12 V d.c.	63	35,8	Ball Bearing	cURus
D12A05HWBZF0	120x120x25	24 V d.c.	150	39,1	Ball Bearing	-
D12A07HWBZF0	120x120x25	48 V d.c.	149	39,1	Ball Bearing	-
D12B05HWBAF0	120x120x38	24 V d.c.	179	46,7	Ball Bearing	-



High temperature resistant AC fans

- High temperature resistant up to 90°C
- All metal construction
- Shaded pole motor
- Wire (W) or terminal (T) connection
- Motor protection: impedance or thermal
- Ball bearing system



Model	Dimensions mm	Rated Voltage V	Max Airflow m³/h	Noise dB(A)	Bearing	Approvals
A09B23HTBMT0	92x92x38	230 V a.c.	75/87	37/42	Ball Bearing	-
A09B23HWBMT0	92x92x38	230 V a.c.	75/87	37/42	Ball Bearing	cURus
A12B23HTBMT0	120x120x38	230 V a.c.	150/175	42/46	Ball Bearing	cURus
A12B23LTBMT0	120x120x38	230 V a.c.	107/110	33/35	Ball Bearing	cURus
A17M12SWBMT0	172x150x55	115 V a.c.	332/391	49/53	Ball Bearing	cURus
A17M23SWBMT0	172x150x55	230 V a.c.	332/391	49/53	Ball Bearing	cURus
A17T23SWBMT0	172x150x55	230 V a.c.	383/434	58/61	Ball Bearing	cURus



All metal AC fans

- Metal fan blades for good corrosion resistance
- Shaded pole motor
- Wire (W) or terminal (T) connection
- Motor protection: impedance or thermal
- Ball bearing system



Model	Dimensions mm	Rated Voltage V	Max Airflow m³/h	Noise dB(A)	Bearing	Approvals
A09B12HWBM00	92x92x38	115 V a.c.	75/87	37/42	Ball Bearing	cURus
A09B23HWBM00	92x92x38	230 V a.c.	75/87	37/42	Ball Bearing	cURus
A17M12SWBM00	172x150x55	115 V a.c.	332/391	49/53	Ball Bearing	cURus
A17M23SWBM00	172x150x55	230 V a.c.	332/391	49/53	Ball Bearing	cURus
A17T12SWBM00	172x150x55	115 V a.c.	383/434	58/61	Ball Bearing	cURus
A17T23SWBM00	172x150x55	230 V a.c.	383/434	58/61	Ball Bearing	cURus

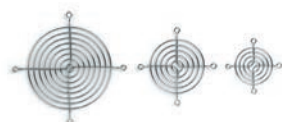

Accessories - Metal fan guards

- Protection from moving parts according to EN ISO 12100 e EN ISO 13858
- Material: steel wire type AISI C1010
- Finishing: nickel-chrome

Model	Dimensions mm	Suitable for fans mm
120	6x116x105	120x120
127	6x116x116	127x127
150	7x154x162	172x150
150/S	7x154x162	172x150
25	2x20x24	25x25
40	5x29x29	40x40
45	4x38x38	45x45
52	5x45x45	50x50
60	4x53x53	60x60
80	6x76x76	80x80
92	6x90x90	92x92
GMP200NK	9x240x250	218x218
GMP250NK	9x295x307	280x280



Accessories - Metal filter

- Protection from moving parts according to EN ISO 12100 e EN ISO 13857
- Materials: 30x30 stainless steel corrugated mesh with 4,8mm pitch and 3,3mm depth, aluminium frame
- Color: natural



Model	Dimensions mm	Suitable for fans mm
FM/120	4x119x119	120x120
FM/150	4x182x182	172x150
FM/60	3x60x60	60x60
FM/80	3x84x84	80x80
FM/92	4x92x92	92x92



Accessories - Metal ventilation louvres

- Protection against moving parts according to EN ISO 12100 e EN ISO 13858
- Material: metal plate painted with epoxy powder RAL 7035

Model	Dimensions	Suitable for fans
	mm	mm
G120M-7035	6x120x120	120x120



Accessories - Plastic fan guards

- Protection against moving parts according to EN ISO 12100 e EN ISO 13858
- Material: PC/ABS self-extinguishing, according to UL 94V-0
- Colour: black RAL 9005
- Available in kits of 50 pieces (_K versions)



Model	Dimensions	Suitable for fans
	mm	mm
G120	7x121x121	120x120
G120K	260x195x140	120x120
G150	11x173x173	172x150
G40	3x42x42	40x40
G40K	3x42x42	40x40
G60	6x60x60	60x60
G60K	200x150x75	60x60
G80	6x81x81	80x80
G80K	190x180x105	80x80
G92	6x92x92	92x92
G92K	120x205x195	92x92

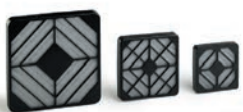

Accessories - Plastic filter

- Protection against moving parts and dust according to EN ISO 12100 and EN ISO 13857
- Plastic parts made of self-extinguishing PC/ABS according to UL-94V-0, RAL 9005 black colour
- Filter cloth made of thermally bonded organic synthetic fibres (polyester and polypropylene), white colour
- Glass fibre mesh 18x16 with wire diameter 0,28mm
- Available in kit of 20 pieces (_K version), model F150/MRK in kit of 10 pieces



Model	Dimensions	Suitable for fans
	mm	mm
F120/MR	13x126x126	120x120
F120/MRK	265x190x134	120x120
F150/MR	25x179x179	172x150
F150/MRK	180x320x190	172x150
F40/MR	7x46x46	40x40
F40/MRK	125x101x54	40x40
F60/MR	12x64x64	60x60
F60/MRK	184x144x74	60x60
F80/MR	12x86x86	80x80



Model	Dimensions mm	Suitable for fans mm
F80/MRK	190x180x105	80x80
F92/MR	12x97x97	92x92
F92/MRK	200x150x110	92x92

Accessories - Spare filter media for plastic filter

- Filter cloth (M_ series) made of thermally bonded organic synthetic fibers (polyester and polypropylene) in white colour
- Filter cloths can be cleaned up to 10 times by washing blowing and beating
- Glass fiber mesh (RP_ series) 18x16 with wide diameter 0,28mm
- Filter cloths available in kit of 200 pieces (_K versions)

kit

Model	Dimensions mm	Suitable for filters mm
M120	8x120x120	F120/MR
M120K	400x400x600	F120/MR
M150	8x172x172	F150/MR
M150K	400x400x600	F150/MR
M40	8x42x42	F40/MR
M40K	260x260x140	F40/MR
M60	8x60x60	F60/MR
M60K	340x340x160	F60/MR
M80	8x81x81	F80/MR
M80K	400x300x220	F80/MR
M92	92x92x8	F92/MR
M92K	400x400x300	F92/MR
RP120	1x119x119	F120/MR
RP150	1x171x171	F150/MR
RP40	1x41x41	F40/MR
RP60	1x59x59	F60/MR
RP80	1x80x80	F80/MR
RP92	1x91x91	F92/MR



Accessories - Fast assembly plastic fan guards

- Protection against moving parts according to EN ISO 12100 e EN ISO 13858
- Self-extinguishing ABS material, according to UL 94HB
- Colour: black RAL 9005



Model	Dimensions mm	Suitable for fans mm
G120/S	20x119x119	120x120
G127/S	19x128x128	127x127
G80/S	17x80x80	80x80



Accessories - Plastic rivets

- Fast assembly of fan and fan guards
- Material: self-extinguishing nylon 6, according to UL 94V-0
- Suitable for fan with fixing hole diameter between 4mm and 4,8mm
- Available with flat or countersunk head
- Two different shank lengths, 17mm and 22mm
- Colour: black RAL 9005 or gray RAL 7032
- Kit of 400 pieces



Model	Dimensions
	mm
FAR175TPNK	17x8x5
FAR175TPRK	17x8x5
FAR175TSNK	17x8x5
FAR175TSRK	17x8x5
FAR225TPNK	22x8x5
FAR225TSNK	8x22x22



Accessories - Elastic rivets

- Fast assembly and disassembly of the fan, vibration and noise reduction
- Material: EPDM rubber, hardness 63 Shore A
- Colour: black
- Kit of 400 pieces



Model	Dimensions
	mm
EAR4401NK	220x150x220



Accessories - Fan power leads

- Quick power connection and disconnection of fans equipped with male faston terminals
- Connector material: self-extinguishing PVC
- Versions available: straight connector, 45° connector (_45 versions), cable with additional protective sheath (_E versions)
- Colour: black

Model	Dimensions
	mm
C100	16x8x2540
C24	8x16x610
C36	8x16x945
C36-45	1x8x930
C60	16x8x1524
C80	16x25x2032
C80E	8x16x2032
CM500E	8x16x5031



Condensation protection solutions

Heaters are used to prevent the formation of condensation inside the electrical panel caused by low temperatures or humidity. They protect the electrical and electronic components from the harmful effects of condensation and corrosion.

FUCSIS
anti-condensation heaters

Most of our products are available
in the industrial engineering software:



■ H SERIES | HEATERS

The heaters, with self-regulating PTC technology, are designed to prevent the formation of condensation and ensure a minimum safe operating temperature inside the electrical cabinet.

The static version is available with metal or touch-safe plastic cover and with cable connection or quick plug-in terminal block.



TOUCH-SAFE PROTECTION

Low surface thermal conductivity to keep safe maintenance operations (plastic version)

CASING MATERIAL

Metal or touch-safe plastic cover

■ **SIMPLE MOUNTING**

Clip fastening system for 35mm DIN rail

ELECTRICAL CONNECTION

Cable or cage clamp tool-less terminal

■ **PRECISE CONTROL**

Can be fitted with optional thermostat or hygrostat to monitor temperatures and humidity levels

APPROVALS



■ Details that make the difference



Cage clamp terminal



Touch-Safe (plastic cover)



Clip system



H series heater with cable

- Metal (HWM) or touch-safe plastic (HWP) cover, accidental contact protection
- 3x20AWG cable with 500mm length
- Clip fastening system for DIN rail TS35
- Heating element consists of a PTC resistor



Model	Dimensions	Rated Voltage	Heating Power	Approvals
	mm		W	
HWM005	78x28x49	110-240 V a.c./d.c.	5	cURus
HWM010	78x28x49	110-240 V a.c./d.c.	10	cURus
HWM015	78x28x49	110-240 V a.c./d.c.	15	cURus
HWM015X	78x28x49	110-240 V a.c./d.c.	15	-
HWM020	78x28x49	110-240 V a.c./d.c.	20	cURus
HWM025	108x28x49	110-240 V a.c./d.c.	25	cURus
HWM030	108x28x49	110-120 V a.c./d.c.	30	cURus
HWM030X	108x28x49	110-240 V a.c./d.c.	30	-
HWM045	108x62x85	110-240 V a.c./d.c.	45	cURus
HWM045X	108x62x85	110-240 V a.c./d.c.	45	-
HWM060	108x62x85	110-240 V a.c./d.c.	60	cURus
HWM060X	108x62x85	110-240 V a.c./d.c.	60	-
HWM080	158x62x85	110-240 V a.c./d.c.	80	cURus
HWM100	158x62x85	110-240 V a.c./d.c.	100	cURus
HWM150	208x62x85	110-240 V a.c./d.c.	150	cURus
HWMS080X	108x62x85	110-240 V a.c./d.c.	80	-
HWMS100X	108x62x85	110-240 V a.c./d.c.	100	-
HWMS150X	158x62x85	110-240 V a.c./d.c.	150	-
HWP045	108x62x85	110-240 V a.c./d.c.	45	cURus
HWP060	108x62x85	110-240 V a.c./d.c.	60	cURus
HWP080	158x62x85	110-240 V a.c./d.c.	80	cURus
HWP100	158x62x85	110-240 V a.c./d.c.	100	cURus
HWP150	208x62x85	110-240 V a.c./d.c.	150	cURus



H series heaters with terminal block

- Metal (HWM) or touch-safe plastic (HWP) cover for accidental contact protection
- Screwless terminals for electrical connection
- Clip fastening system for DIN rail TS35
- Heating element consists of a PTC resistor



Model	Dimensions mm	Rated Voltage	Heating Power W	Approvals
HTM045	138x62x85	110-240 V a.c./d.c.	45	cURus
HTM060	138x62x85	110-240 V a.c./d.c.	60	cURus
HTM080	188x62x85	110-240 V a.c./d.c.	80	cURus
HTM100	188x62x85	110-240 V a.c./d.c.	100	cURus
HTM150	238x62x85	110-240 V a.c./d.c.	150	cURus
HTMS080X	138x62x85	110-240 V a.c./d.c.	80	-
HTMS100X	138x62x85	110-240 V a.c./d.c.	100	-
HTMS150X	188x62x85	110-240 V a.c./d.c.	150	-
HTP045	138x62x85	110-240 V a.c./d.c.	45	cURus
HTP060	138x62x85	110-240 V a.c./d.c.	60	cURus
HTP080	188x62x85	110-240 V a.c./d.c.	80	cURus
HTP100	188x62x85	110-240 V a.c./d.c.	100	cURus
HTP150	238x62x85	110-240 V a.c./d.c.	150	cURus



H series heaters with fan

- Metal (HVM) or touch-safe plastic (HVP) cover for accidental contact protection
- Screwless terminals for electrical connection
- Clip fastening system for DIN rail TS35
- Heating element consists of a PTC resistor with integrated bimetal thermal protector



Model	Dimensions mm	Rated Voltage	Heating Power W	Approvals
HVMS200THP-115	143x62x85	115 V a.c.	200	cURus
HVMS200THP-230	143x62x85	230 V a.c.	200	-
HVMS250THP-115	193x62x85	115 V a.c.	250	cURus
HVMS250THP-230	193x62x85	230 V a.c.	250	cURus
HVMS350THP-115	243x62x85	115 V a.c.	350	cURus
HVMS350THP-230	243x62x85	230 V a.c.	350	-
HVPS200THP-115	143x62x85	115 V a.c.	200	cURus
HVPS200THP-230	143x62x85	230 V a.c.	200	-
HVPS250THP-115	193x62x85	115 V a.c.	250	cURus
HVPS250THP-230	193x62x85	230 V a.c.	250	cURus
HVPS350THP-115	243x62x85	115 V a.c.	350	cURus
HVPS350THP-230	243x62x85	230 V a.c.	350	-

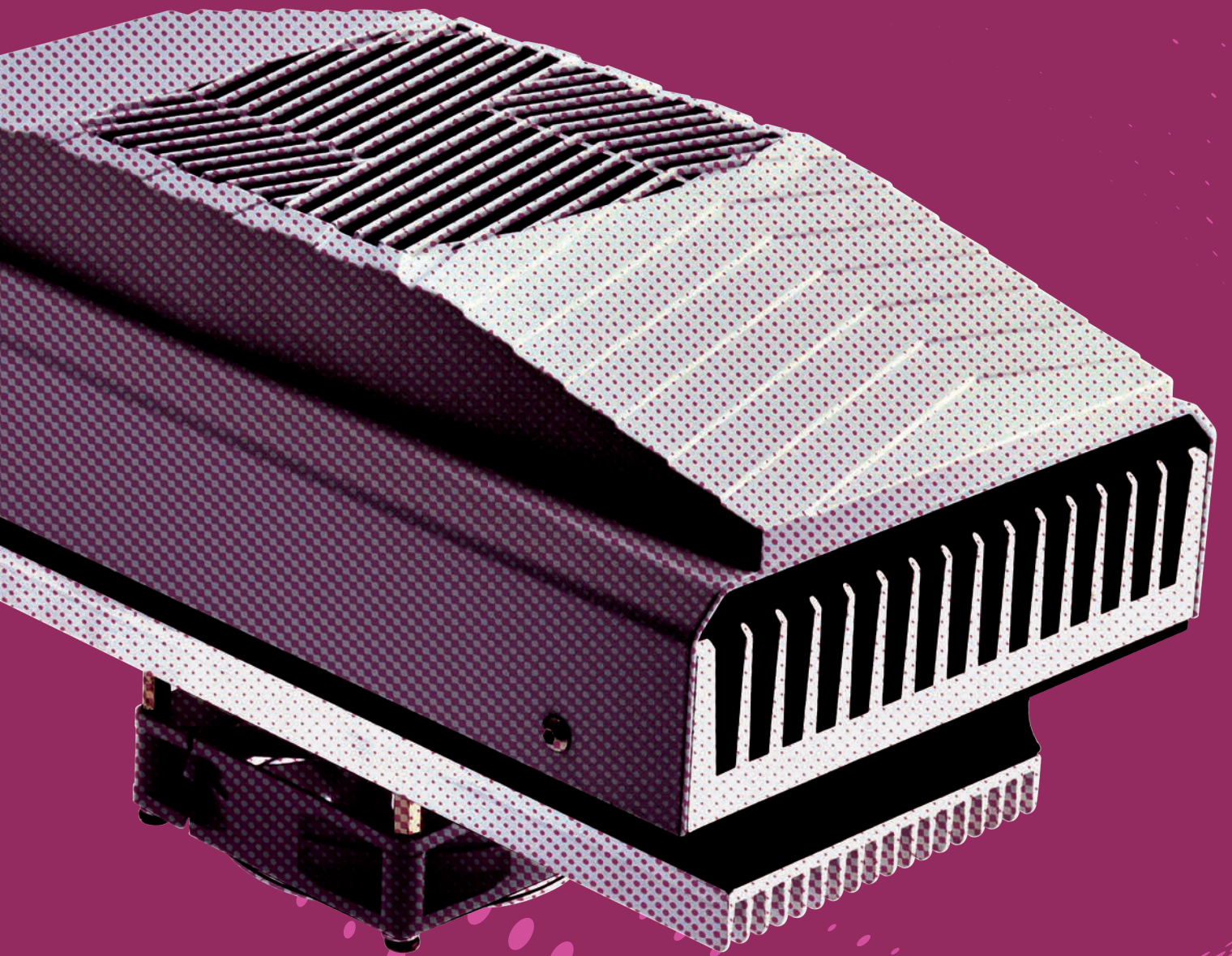

Cooling solutions

Thermoelectric technology is applied to air conditioning units to cool and dehumidify small electrical panels, keeping the internal and external environments separate from each other.

bordos
heat pumps

Most of our products are available
in the industrial engineering software:



What is a thermoelectric unit?

A thermoelectric unit is a device for the transfer of heat. Such units come ready for fitting and cool using electrical energy only.

Thermoelectric units achieve the same results as traditional compressor systems without the use of gas or moving components (except fans, if applicable).

HOW DO THERMOELECTRIC UNITS WORK?

Thermoelectric units are simply small static heat pumps, which use the so-called “Peltier” effect.

Heat is transferred as a result of a flow of electrical current through thermoelectric modules, which are the main components in the system. Heat is absorbed by one side of the unit (the cold side) and as a result the temperature drops. The other side dissipates the heat into the surrounding environment (hot side). The process can be reversed by simply inverting the direction of the current flow.

WHAT ARE THE ADVANTAGES COMPARED TO A COMPRESSOR SYSTEM?

Thermoelectric units have no moving mechanical parts (except fans, if applicable) and are therefore extremely reliable, have an almost unlimited life span and require no maintenance.

The fact that they are “static” makes them immune to vibration meaning they can be used in any position, which makes them particularly suitable for applications where they are mounted on systems in motion.

They contain no pollutants such as CFC or other gases, which can harm the environment ambient and have simpler and more compact structure than compressor systems.



Thermoelectric cooling units are used to cool and dehumidify the air inside electrical cabinets and to separate the internal and exterior environments.

Air conditioners are usually used when outside temperatures are unfavorable i.e. over 35°C and the atmosphere is contaminated by oil or dust.

■ AC - DC | THERMOELECTRIC UNITS

Thermoelectric units are based on the Peltier effect heat pump principle and are used for air-conditioning small panels and electrical equipment. They do not use a compressor or other moving parts (except for the fan). They do not use gases, such as CFC or others, and are insensitive to vibrations. DC and AC versions available.



DUAL EFFECT

Heating and cooling conversion by reversing polarity

QUIET OPERATION

Compressor-free and no moving parts, except for the fan

REFRIGERANT-FREE

No dangerous fluids exploiting the Peltier effect cooling system

IP55

High protection from moisture and dust

■ Details that make the difference

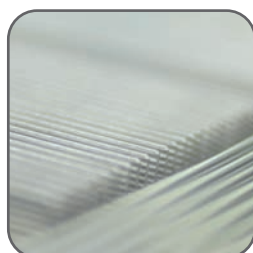

Efficient heat sink



Peltier module



Custom design

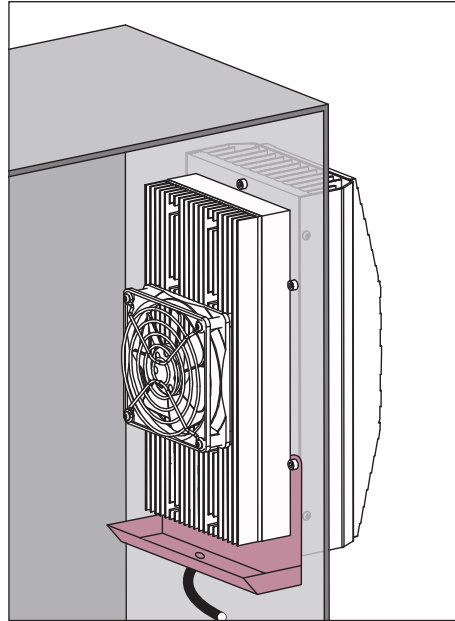

TCU50 and TCU100
max. height with drip tray

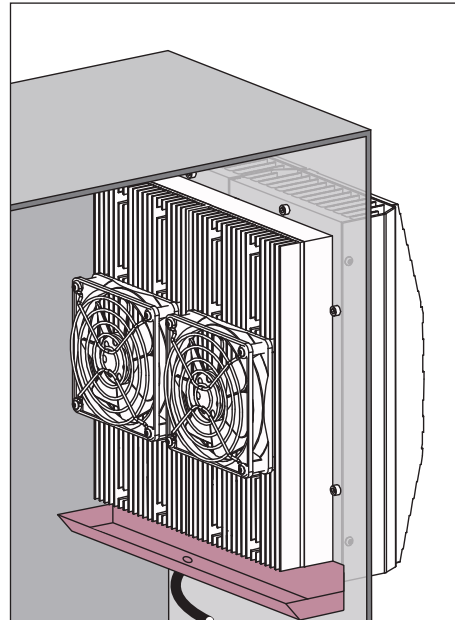
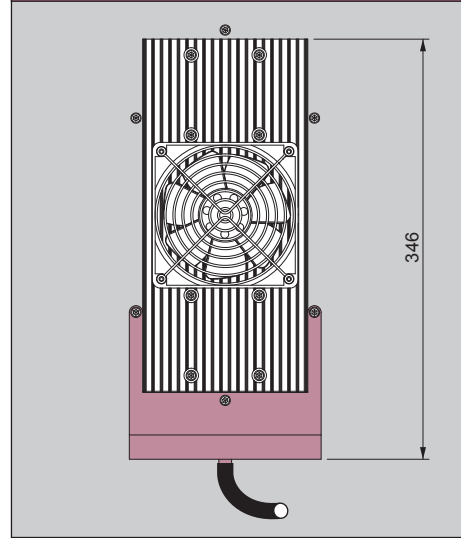

TCU200 / TCU200AC
max. height with drip tray

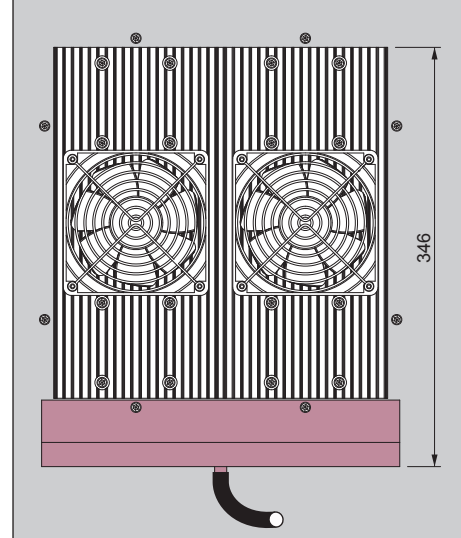

Model numbering system for DC THERMOELECTRIC UNITS

<i>description</i>	TCU 100 24 40 IP55 - 7035	<i>description</i>
FAMILY TCU		COLOUR 7035 = grey RAL 7035
COOLING POWER 50 = 50 W 100 = 100 W 200 = 200 W		IP protection degree of the external side
VOLTAGE 12 = 12 Vd.c. 24 = 24 Vd.c. 48 = 48 Vd.c.		SERIES 40 = standard

Model numbering system for AC THERMOELECTRIC UNITS

<i>description</i>	TCU 200 AC 40 - SIP	<i>description</i>
FAMILY TCU		CUSTOM SERIES S** = custom version
COOLING POWER 200 = 200 W		
VOLTAGE AC = Va.c.		SERIES 40 = standard



DC thermoelectric units

- Solid-state device with Peltier technology
- Suitable for any plate thickness
- No chlorofluorocarbons (CFC) and compressor
- Reversible process heat/cool
- Operation in any orientation
- Not sensitive to vibration
- Virtually free maintenance - no moving parts (except for the fans)



Model	Rated Voltage	Operating Voltage	Rated Current	Max Current	Rated Cooling Power
	V	V	A	A	W
TCU1002440IP55-7035	24 V d.c.	17-27 V d.c.	4,7	5,7	101
TCU1004840IP55-7035	48 V d.c.	34-54 V d.c.	2,4	3,0	101
TCU2002440IP55-7035	24 V d.c.	17-27 V a.c.	9,5	11,5	201
TCU2004840IP55-7035	48 V d.c.	34-54 V a.c.	4,8	6,0	201
TCU501240IP55-7035	12 V d.c.	7-13 V d.c.	5,0	5,8	57
TCU502440IP55-7035	24 V d.c.	10-27,6 V d.c.	2,4	2,8	57

AC thermoelectric units



- Solid-state device with Peltier technology
- Suitable for any plate thickness
- Stainless steel external cover
- Integrated AC/DC power supply on the other cover
- No chlorofluorocarbons (CFC) and compressor
- Operation in any orientation
- Not sensitive to vibration
- Virtually free maintenance - no moving parts (except for the fans)



Model	Operating Voltage	Rated Power	Max Power	Rated Cooling Power
	V	W	W	W
TCU200AC40-SIP	88-264 V a.c.	245	306	201

Thermoelectric modules



- Semiconductor-based electronic components
- Core system of the thermoelectric units
- No chlorofluorocarbons (CFC)
- Reversible process heat/cool
- Not sensitive to vibrations



Model	Dimensions	Max Current	Max Voltage	Max Cooling Power
	mm	A	V	W
TM1-1274060-HXHP	40x40x4	6,0	15,3 V d.c.	60



Accessories - Drip trays

- Stainless steel accessories used to collect the condensate generated on the cold heat sink inside the enclosure
- Suitable for vertical installation of the thermoelectric units

Model	Suitable for TE units
RC-TCU100-1001	TCU100
RC-TCU200-1001	TCU200
RC-TCU50-1001	TCU50

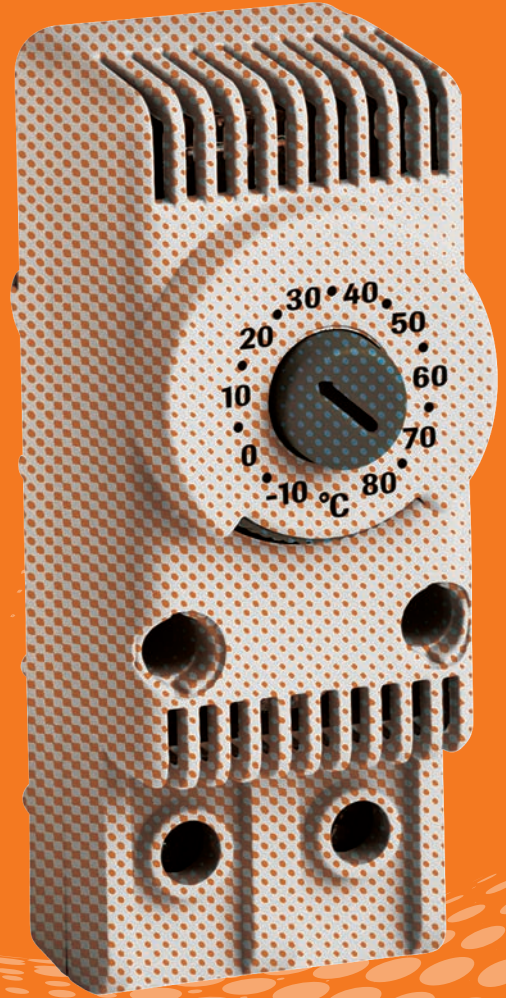
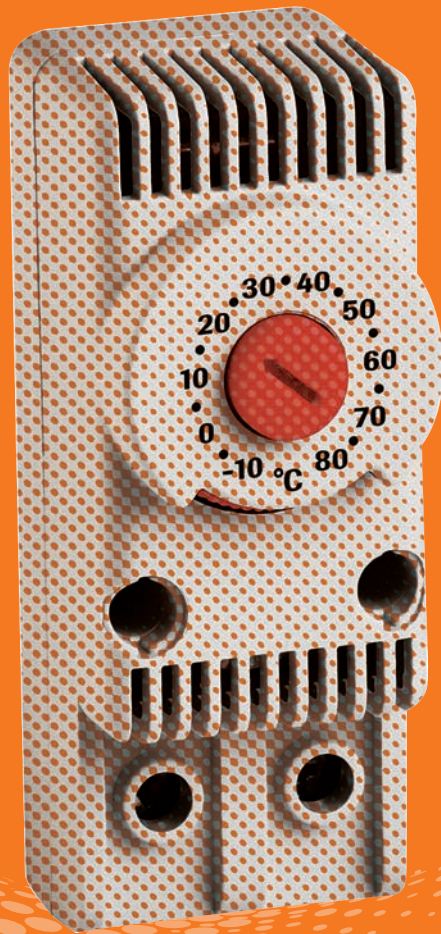

Thermal control solutions

The thermal control devices can regulate the temperature and humidity levels inside the cabinet to maintain optimal climatic conditions, with the possibility of electronic monitoring of thermal parameters by using the network infrastructure and Industrial Internet of Things (IIoT).

orangis
ambient control

Most of our products are available
in the industrial engineering software:



■ SINGLE THERMOSTATS

The single thermostats meet the requirements for temperature control in the electrical cabinet. By adjusting the activation threshold, the thermostat can operate cooling or heating units while keeping the temperature above the dew point. They are available with closing, opening or change-over contact.

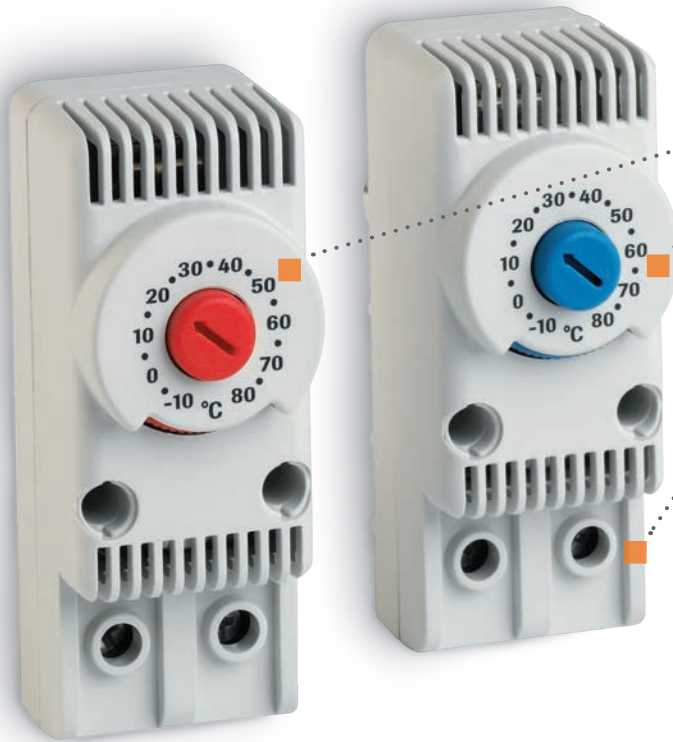

■ VERSIONS

Available with normally closed, normally open and change-over contacts

SET POINT

Wide temperature setting range with Celsius or Fahrenheit scales

ELECTRICAL CONNECTION

Screw terminals

■ SIMPLE MOUNTING

Snap-on fastening system for DIN rails

■ APPLICATIONS

Switching contact for fan filters, heaters and cooling unit or signal devices

APPROVALS



Details that make the difference



°C and °F scales



Disk setting by hand or tool



Patented clip-on system

■ TWIN THERMOSTATS

Twin thermostats are used where multiple drives are required. The unit integrates two independently operable devices into one compact assembly for simultaneously controlling heating, cooling or signalling devices via two knobs.



SET POINT
Wide temperature setting range with Celsius or Fahrenheit scales

VERSIONS
Available with normally closed/normally open, normally closed/normally closed and normally open/normally open contacts

SIMPLE MOUNTING
Snap-on fastening system for 35mm DIN rails

DUAL SYSTEM
Separate adjustment and operation

APPLICATIONS
Switching contact for fan filters, heaters and cooling unit or signal devices

ELECTRICAL CONNECTION
Screw terminals



Model numbering system for SINGLE AND TWIN THERMOSTATS

description	TRT	10A	230V	-	NC	F	PA00	description
FAMILY TRT TRT = single thermostat TRT2 = twin thermostat								CUSTOM SERIES PA** = custom version
RATED CURRENT								SCALE () = °C (Celsius) F = °F (Fahrenheit)
RATED VOLTAGE								
VERSION Single thermostat NC = Normally Closed NO = Normally Open	Twin thermostat NCNC = Normally Closed / Normally Closed NCNO = Normally Closed / Normally Open NONO = Normally Open / Normally Open							

■ HYGROSTATS

Hygrostats detect the level of humidity in the air inside the electrical cabinet and operate the cooling or heating units when a set relative humidity value is exceeded to avoid the formation of condensation on the electrical components.



ELECTRICAL CONNECTION

Screw terminals

SIMPLE MOUNTING

Snap-on fastening system for 35mm DIN rails

APPLICATIONS

Combined with heaters or fan filters for a precise control of humidity levels



Model numbering system for HYGROSTATS

<i>description</i>	IGR	35	F	-	PA00	<i>description</i>
FAMILY IGR IGR = Hygrostat						CUSTOM SERIES PA** = custom version
SUPPORT 35mm DIN rail						VERSION F = Fandis

■ SENSIS | ELECTRONIC DEVICE

Sensis is an IIoT device designed to detect temperatures in up to three critical zones and monitor the efficiency of ventilation and cooling systems for more efficient thermal management of the electrical cabinet. It can be used to display real-time climate data aboard the machine even remotely and track trends over time to plan predictive maintenance.



WIRING

Simple and user-friendly via clamps arranged in the upper part

DESIGN

Compact device for managing various complex functions

DISPLAY

Backlit for setting up and displaying climate data locally

INTEROPERABILITY

With the main fieldbuses or network

ACCURATE MEASUREMENTS

Using integrated sensors and additional ventilation and temperature probes

PREDICTIVE MAINTENANCE

Data logging for diagnostic purposes

APPROVALS



Details that make the difference



Display for set-up and climate data



Dashboard



DIN rail mounting



NO-NC Thermostats

- Versions available: NC (red disc) with normally closed contact to control heating systems and NO (blue disc) with normally open contact to control cooling systems
- Patented snap-on fastening system on DIN rails TS35/15/32
- Wide temperature setting range with Celsius (°C) or Fahrenheit (°F) scales
- Disc setting by hand or tool
- Standard colour RAL 7035



Model	Rated Voltage	Rated Current	Max Contact Current	Setting Range	Approvals
		A	A		
TRT-10A230V-NC	110-250 V a.c.; 60 V d.c.	10	15	-10÷80 °C	cURus
TRT-10A230V-NCF	110-250 V a.c.; 60 V d.c.	10	15	14÷176 °F	cURus
TRT-10A230V-NO	110-250 V a.c.; 60 V d.c.	10	15	-10÷80 °C	cURus
TRT-10A230V-NOF	110-250 V a.c.; 60 V d.c.	10	15	14÷176 °F	cURus



Twin thermostats

- Available with Normally Closed/Normally Open (NC/NO), Normally Closed/Normally Closed (NC/NC) and Normally Open/Normally Open (NO/NO)
- Separate adjustment and operation of the devices
- Snap-on fastening system on DIN rail TS35
- Wide temperature range with Celsius (°C) or Fahrenheit (°F) scales
- Disc setting by hand or tool
- Standard colour RAL 7035



Model	Rated Voltage	Rated Current	Max Contact Current	Setting Range	Approvals
		A	A		
TRT2-10A230V-NCNC	110-250 V a.c.; 60 V d.c.	10	15/15	-10÷80 °C	cURus
TRT2-10A230V-NCNCF	110-250 V a.c.; 60 V d.c.	10	15/15	14÷176 °F	cURus
TRT2-10A230V-NCNO	110-250 V a.c.; 60 V d.c.	10	15/15	-10÷80 °C	cURus
TRT2-10A230V-NCNOF	110-250 V a.c.; 60 V d.c.	10	15/15	14÷176 °F	cURus
TRT2-10A230V-NONO	110-250 V a.c.; 60 V d.c.	10	15/15	-10÷80 °C	cURus
TRT2-10A230V-NONOF	110-250 V a.c.; 60 V d.c.	10	15/15	14÷176 °F	cURus



Change-over thermostat

- Change over contact
- Snap-on fastening system DIN rail TS35
- Standard colour RAL 7035



Model	Rated Voltage	Rated Current	Max Contact Current	Setting Range
		A	A	°C
TRT-230V-S01	230 V a.c.	Heating a.c. 10(4) -Cooling a.c. 5(2)	10	5÷60



Hygrostats

- Snap-on fastening system on DIN rail TS35
- Disc setting by hand or tool
- Standard colour RAL 7035
- UL approved till max 80% RH



Model	Rated Voltage	Rated Current	Setting Range	Approvals
		A	% RH	
IGR35F	120-240 V a.c.	10-5	10-90	cURus



Sensis - Electronic device for thermal management

- Regulates, monitors, manages, communicates
- Acquisition and management of temperature parameters in three different points (probes included), relative humidity, ventilation efficiency, door limit switch status
- Supervision in interoperability with the main industrial field buses and MQTT / OPCUA versions
- Historical and basic statistical data that can be used remotely
- Snap fastening system for DIN rail
- Standard colour RAL 7035
- Compact dimensions: 98x35x120 mm
- Rated voltage: 24 Vd.c.

Model	Version	Approvals
SNS00U00	Sensis stand alone (no interface)	cULus
SNS01U00	Sensis Modbus RTU	cULus
SNS02U00	Sensis Profinet	cULus
SNS02UM00	Sensis Profinet MQTT	cULus
SNS03U00	Sensis ASI	cULus
SNS04U00	Sensis CAN-OPEN	cULus
SNS05U00	Sensis CC link	cULus
SNS06U00	Sensis Ethercat	cULus
SNS07U00	Sensis Modbus/TCP	cULus
SNS08U00	Sensis Profibus	cULus
SNS09U00	Sensis SERCOS III	cULus
SNS10U00	Sensis IO LINK	cULus
SNS11U00	Sensis EtherNet/IP	cULus
SNS11UM00	Sensis EtherNet/IP MQTT	cULus
SNS12U00	Sensis VARAN	cULus
SNS13U00	Sensis POWERLINK	cULus



Accessories - Sensis

- SNSTU00: Probe for detecting temperature in the most critical points of the cabinet
- Type of sensor: ntc, magnetic fixing, cable 1500mm
- SNSWU00: Probe for detecting air speed in the cooling flow
- Type of sensor: electronic, clip fixing, cable 1500mm

Model	Version
SNSTU00	Temperature probe
SNSWU00	Airflow probe

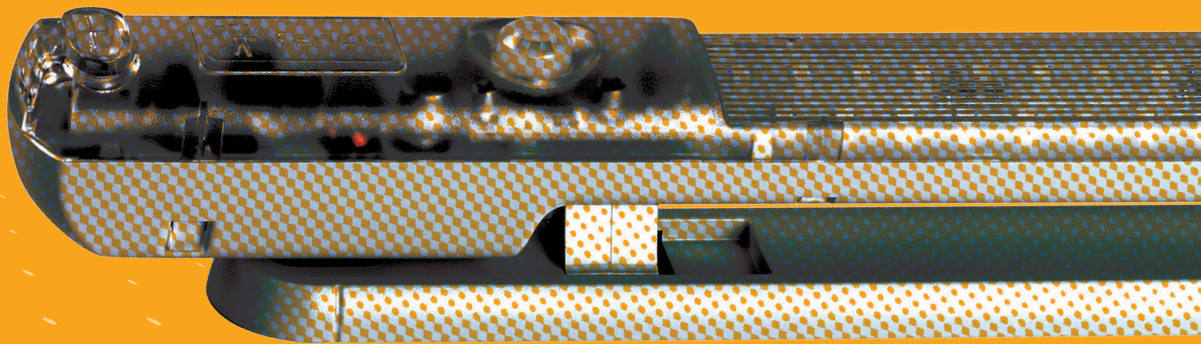

Lighting solutions

LED lamps guarantee a high level of energy efficiency and good illumination inside the electrical panel, simplifying installation operations and reducing the risk of error during inspection and maintenance.

lumeis
enclosure lamps

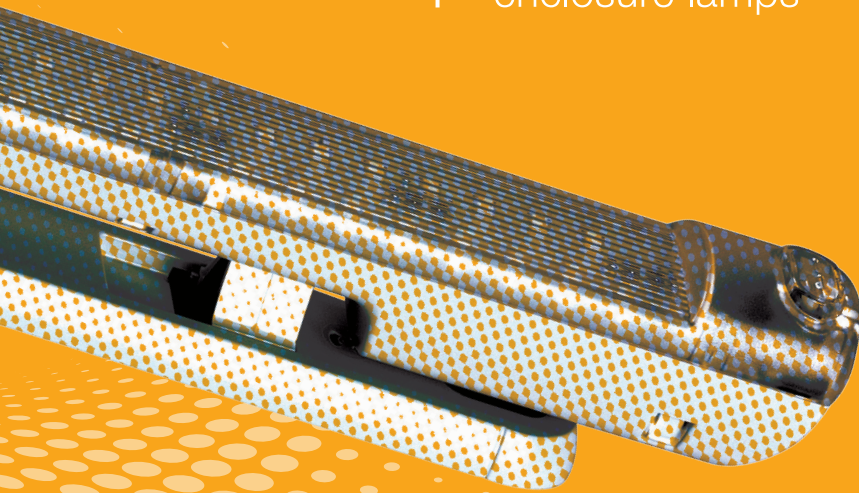

Most of our products are available
in the industrial engineering software:



■ FLL SERIES | LED LAMPS

The FLL series of LED lamps - AC (single or multi-voltage) and DC - can be installed with screw or magnetic fixing (optional) and have a swivelling body to better distribute the light according to the situation of use. They are equipped with an ON/OFF switch or motion sensor and a quick plug-in or Wieland connection system.

■ ADJUSTABLE LIGHT BEAM

Variable beam direction by 40° per side for directing the distribution of light

■ FLEXIBLE INSTALLATION

Standard screw-in or optional magnetic fastening for metallic surfaces

SWITCH

ON/OFF or PIR movement sensor

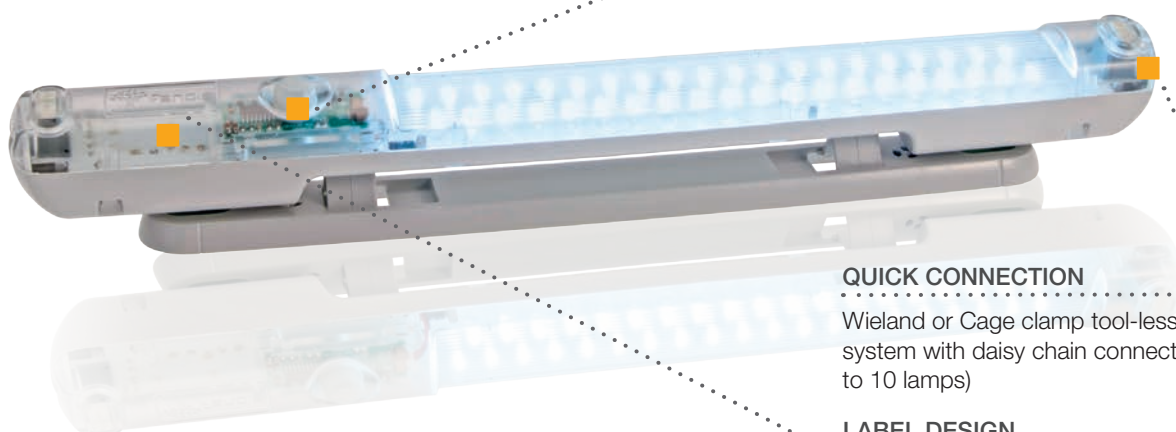

QUICK CONNECTION

Wieland or Cage clamp tool-less wiring system with daisy chain connection (up to 10 lamps)

LABEL DESIGN

Adhesive or in relief customized label

■ ENERGY EFFICIENCY

Long-life and low consumption by LED technology

APPROVALS



■ Details that make the difference



Swivelling system



Cage clamp or Wieland connection



Magnetic fixing

CLG-L SERIES | LED LAMPS

The CLG-L series of LED lamps are available with AC voltage and ON/OFF switch. They have a fixing system with metal brackets, specially designed for adjustable positioning and greater ease of use.



SIMPLE POSITIONING

Metal fixing brackets for adjustable lamp fixing

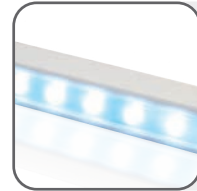

ENERGY SAVING

Long-life and low consumption with LED technology

Model numbering system for FLL SERIES

<i>description</i>	FLL - 23 05 65 U - S V M X - S00	<i>description</i>
FAMILY FLL = Fandis LED lamp		CUSTOM SERIES S** = custom version
VOLTAGE 12 = 115 Va.c. D12 = 12 Vd.c. 23 = 230 Va.c. D24 = 24 Vd.c. 30 = 115-230 Va.c. D48 = 48 Vd.c.		APPROVALS X = only CE version () = UL version
RATED POWER 05 = 5 W		INSTALLATION M = magnet pot () = by screw
CORRELATED COLOR TEMPERATURE 65 = 6500÷7500K		CONNECTION V = single connector () = standard cage clamp
PLASTIC COLOUR U = grey RAL 7035		SWITCH S = switch IR = PIR sensor

Model numbering system for CLG-L SERIES

<i>description</i>	CLG-L 30 7	<i>description</i>
FAMILY CLG-L = a.c. LED lamp		RATED POWER 7 = 7 W
		RATED VOLTAGE 30 = 115-230 Va.c.



FLL series AC LED lamps

- Long life and low energy consumption by LED technology
- ON/OFF switch (-S) or PIR movement sensor (-IR)
- Standard screw-in or, optionally, magnetic fastening for metallic surfaces (-IRM o -SM models)
- Wieland (-IRV o -SV models, female connector not included) or screwless wiring system
- Daisy chain connection (up to 10 units), except model with Wieland connection
- Adjustable light beam



Model	Dimensions	Rated Voltage	Rated Power	Approvals
	mm	V	W	
FLL-120565U-IR	48x32x356	115 V a.c.	5	cURus
FLL-120565U-IRM	48x32x356	115 V a.c.	5	cURus
FLL-120565U-IRV	46x32x364	115 V a.c.	5	cURus
FLL-120565U-IRVM	46x32x364	115 V a.c.	5	cURus
FLL-120565U-S	48x32x356	115 V a.c.	5	cURus
FLL-120565U-SM	48x32x356	115 V a.c.	5	cURus
FLL-120565U-SV	46x32x364	115 V a.c.	5	cURus
FLL-120565U-SVM	46x32x364	115 V a.c.	5	cURus
FLL-230565U-IR	48x32x356	230 V a.c.	5	cURus
FLL-230565U-IRM	48x32x356	230 V a.c.	5	cURus
FLL-230565U-IRV	46x32x364	230 V a.c.	5	cURus
FLL-230565U-IRVM	46x32x364	230 V a.c.	5	cURus
FLL-230565U-S	48x32x356	230 V a.c.	5	cURus
FLL-230565U-SM	48x32x356	230 V a.c.	5	cURus
FLL-230565U-SV	46x32x364	230 V a.c.	5	cURus
FLL-230565U-SVM	46x32x364	230 V a.c.	5	cURus
FLL-300565U-IR	48x32x356	115-230 V a.c.	5	cURus
FLL-300565U-IRM	48x32x356	115-230 V a.c.	5	cURus
FLL-300565U-IRV	46x32x364	115-230 V a.c.	5	cURus
FLL-300565U-IRVM	46x32x364	115-230 V a.c.	5	cURus
FLL-300565U-S	48x32x356	115-230 V a.c.	5	cURus
FLL-300565U-SM	48x32x356	115-230 V a.c.	5	cURus
FLL-300565U-SV	46x32x364	115-230 V a.c.	5	cURus
FLL-300565U-SVM	46x32x364	115-230 V a.c.	5	cURus



FLL series DC LED lamps

- Long life and low energy consumption by LED technology
- ON/OFF switch (-S) or PIR movement sensor (-IR)
- Standard screw-in or, optionally, magnetic fastening for metallic surfaces (-IRM o -SM models)
- Wieland (-IRV o -SV models, female connector not included) or screwless wiring system
- Daisy chain connection (up to 10 units), except model with Wieland connection
- Adjustable light beam
- Self-correction of polarity inversion



Model	Dimensions mm	Rated Voltage V	Rated Power W	Approvals
FLL-D120565U-IR	48x32x356	12 V d.c.	5	cURus
FLL-D120565U-IRM	48x32x356	12 V d.c.	5	cURus
FLL-D120565U-IRV	46x32x364	12 V d.c.	5	cURus
FLL-D120565U-IRVM	46x32x364	12 V d.c.	5	cURus
FLL-D120565U-S	48x32x356	12 V d.c.	5	cURus
FLL-D120565U-SM	48x32x356	12 V d.c.	5	cURus
FLL-D120565U-SV	46x32x364	12 V d.c.	5	cURus
FLL-D120565U-SVM	46x32x364	12 V d.c.	5	cURus
FLL-D240565U-IR	48x32x356	24 V a.c./d.c.	5	cURus
FLL-D240565U-IRM	48x32x356	24 V a.c./d.c.	5	cURus
FLL-D240565U-IRV	46x32x364	24 V a.c./d.c.	5	cURus
FLL-D240565U-IRVM	46x32x364	24 V a.c./d.c.	5	cURus
FLL-D240565U-S	48x32x356	24 V a.c./d.c.	5	cURus
FLL-D240565U-SM	48x32x356	24 V a.c./d.c.	5	cURus
FLL-D240565U-SV	46x32x364	24 V a.c./d.c.	5	cURus
FLL-D240565U-SVM	46x32x364	24 V a.c./d.c.	5	cURus
FLL-D480565U-IR	48x32x356	48 V d.c.	5	cURus
FLL-D480565U-IRM	48x32x356	48 V d.c.	5	cURus
FLL-D480565U-IRV	46x32x364	48 V d.c.	5	cURus
FLL-D480565U-IRVM	46x32x364	48 V d.c.	5	cURus
FLL-D480565U-S	48x32x356	48 V d.c.	5	cURus
FLL-D480565U-SM	48x32x356	48 V d.c.	5	cURus
FLL-D480565U-SV	46x32x364	48 V d.c.	5	cURus
FLL-D480565U-SVM	46x32x364	48 V d.c.	5	cURus

Accessories - FLL series



- CE-006WF Female Wieland connector for -IRV e -SV versions
- Connector not included in the lamp package, to be ordered separately
- FLL-2MA Pair of magnets for upgrading versions not equipped with magnetic fixing

Model	Version
CE-006WF	Wieland GST15 2 poles electrical connector
FLL-2MA	Pot magnet kit 2 pieces



CLG-L series LED lamps

- Long life and low energy consumption by LED technology
- ON/OFF switch
- Metal fixing brackets for an adjustable lamp position DIN 25mm
- Power supply cable (length 1800mm) and multiple connection cable (length 160mm) included



Model	Dimensions	Rated Voltage	Rated Power
	mm	V	W
CLG-L307	79x23x402	115-240 V a.c.	7.5

Complementary solutions

Accessory products to equip the electrical cabinet completely and functionally, with accessories such as document holder, directional fans and door limit switches.

indacus
enclosure components

Most of our products are available
in the industrial engineering software:





Directional fan

- Prevents hot spots inside the cabinet
- Vertical/horizontal adjustable position
- Quick electrical connection with screwless terminals
- Metal protection guards on both side
- Frequency: 50/60Hz

Model	Rated Voltage	Rated Power	Max Airflow
	V	W	m³/h
OF-A12B23SWBAQ130	230 V a.c.	21/21	163/182



Document holder

- Holds documents in A4 format
- Fixing through a pre-arranged double side adhesive tape
- Standard colour RAL 7035

Model	Dimensions
	mm
TPD-A4	235x264x31



Door limit switches

- Disable the voltage inside a switch cabinet or control other devices to operate safely on the components
- Versions: plain plunger (FC-001), plain plunger with manual reset (FC-002), roller plunger (FC-003), roller plunger with adjustable lever (FC-004), plain plunger with 3 NC contacts (FC-005)
- For all versions: No. 1 Normally Open (NO) e No. 1 Normally Closed (NC) contact, except for FC-005 model with no.3 Normally Closed (NC) contact



Model	Rated Voltage	Rated Current	Approvals
	V	A	
FC-001	24-400 V a.c.; 24-250 V d.c.	6-0,4 A (d.c.); 10-4 A (a.c.)	cULus
FC-002	24-400 V a.c.; 24-250 V d.c.	6-0,4 A (d.c.); 10-4 A (a.c.)	cULus
FC-003	24-400 V a.c.; 24-250 V d.c.	6-0,4 A (d.c.); 10-4 A (a.c.)	cULus
FC-004	24-400 V a.c.; 24-250 V d.c.	6-0,4 A (d.c.); 10-4 A (a.c.)	cULus
FC-005	24-400 V a.c.; 24-250 V d.c.	6-0,4 A (d.c.); 10-4 A (a.c.)	cULus



Accessories - Slide limit switch

- Plastic support for easy positioning of FC series door limit switch
- The packaging consists of No. 1 slide for limit switch, No. 2 screws and No. 2 nuts
- Kit of 30 pieces



Model	Dimensions
	mm
SA-FC01K	65x40x12

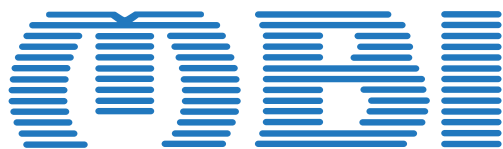

MBI GmbH

Ubstadter Pfad 5
76694 Forst

Telefon: +49 (0) 7251 - 30 20 408
Telefax: +49 (0) 7251 - 30 20 409

E-Mail: info@mbi-gmbh.de
Webseite: www.mbi-gmbh.de