





# VALVE BODY W9 MINI TRI-CLAMP





ART. NO. 850036

## GENERAL

-  The KEOFITT CLASSIC W9 Sampling Valve is the original and leading sterilizable sampling valve in the world. Used in all industries for decades. More than 320 standard valve configurations. Unique serial no. for each valve\*.
-  The sampling valve can be used for any process sampling for microbiological, chemical and/or physical analysis.
-  **Cleaning/sterilizing:** Between batches: Valve in open position: Cleanable by means of CIP using the detergent solution suitable for the actual process media. Between samples: Valve in its normal closed position: cleanable by CIP as "Between batches" or the valve may be sterilized by means of steam SIP or chemical SIP using a procedure appropriate to the actual circumstances. For further advice, please contact Keofitt.
-  Designed for sampling of liquids with a viscosity of up to approx. 1.000 cP containing no particles larger than Ø3 mm. Sampling of more viscous liquids is possible, only will it take longer (depending on process pressure).



## FEATURES

-  Installation: Mini Tri-Clamp DIN 32676:2009-05 Table 4 Row C
-  Operation: Depending on choice of valve head
-  Inlet / Outlet: Hose piece
-  Membrane: Depending on choice of valve head

## CERTIFICATION\*

- EU EC 1935/2004 · EU EC 2023/2006 · DK No.822 06/2013 · 3-A Certificate · 3.1 Material Certificate · Ra Certificate
- ATEX 94/9/EC & 2014/34/EU · PED 2014/68/EU · EHEDG (2007) · Keofitt DoC

## TECHNICAL DATA

### Material (product contact)

- Steel parts                      AISI 316L (1.4404)

### Material (without product contact)

- Steel parts                      AISI 316L (1.4404)
- Rubber cap                      EPDM (black)
- Stainless steel chain           AISI 316L (1.4404)

### Surface Treatment

- Outside                          Electropolished Ra ≤ 1.2 µm
- Inside (wetted surface)        Electropolished Ra ≤ 0.5 µm
- Process connection            Electropolished Ra ≤ 0.5 µm

### Pressure & Temperature

- Pressure                          Depending on choice of valve head
- Temperature                      Depending on choice of valve head
- Air supply                          Depending on choice of valve head

### Net Weight

- kg/lbs                                0.308 kg/0.679 lbs





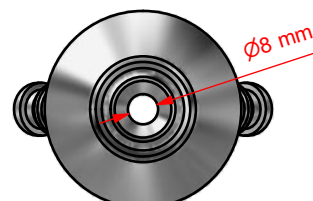
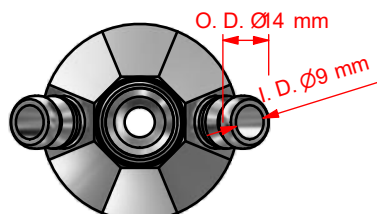
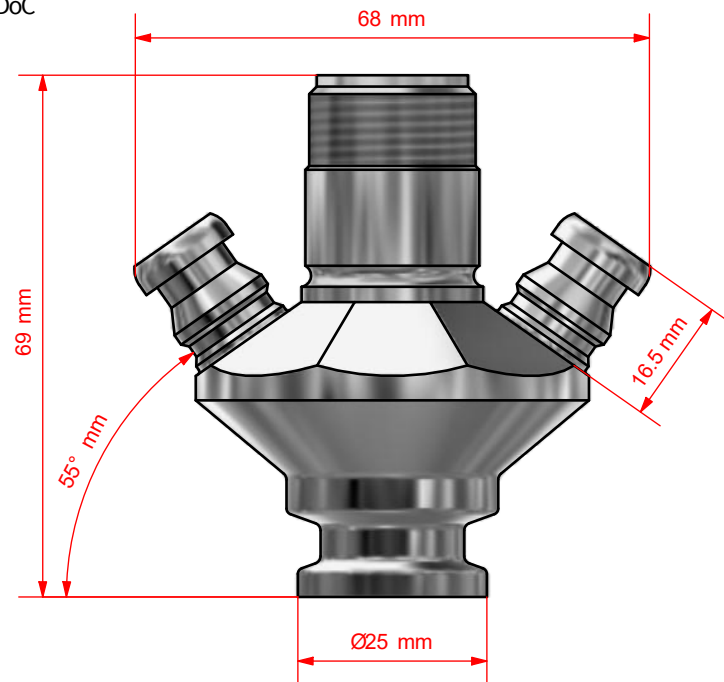











### Spareparts

















- 778501                                PARTS FOR W9 850001/03/11/14/21/27/28/36



\*For further information and download please visit [www.keofitt.dk](http://www.keofitt.dk)

# KEOFITT CLASSIC W9 SAMPLING VALVE - HEADS

W9 HEADS				
	TYPE H TURN KNOB 0-10 BAR (FFKM 0-5 BAR)	TYPE H TURN KNOB W/ MICROPORT 0-10 BAR	TYPE K KEY RING 0-10 BAR (FFKM 0-5 BAR)	TYPE K KEY RING W/OPT. MICROPORT 0-10 BAR
SILICONE	 600041	 600048	 600042	 600049
EPDM	 600041E	 600048E	 600042E	 600049E
FFKM	 600041F	 Not available	 600042F	 Not available
PTFE	 855541	 Not available	 855542	 Not available

TYPE Q LEVER HANDLE 0-10 BAR (FFKM 0-6 BAR)	 600043	TYPE N PNEUMATIC 0-10 BAR (FFKM 0-6 BAR)	 600044	TYPE N PNEUMATIC, ADJUSTABLE 0-10 BAR (FFKM 0-6 BAR)	 600045	TYPE B NO SPRING 0-12 BAR(G)	 600047
 600043E	TYPE N PNEUMATIC 0-10 BAR (FFKM 0-6 BAR)	 600044E	TYPE N PNEUMATIC, ADJUSTABLE 0-10 BAR (FFKM 0-6 BAR)	 600045E	 600047E		
 600043F	TYPE N PNEUMATIC 0-10 BAR (FFKM 0-6 BAR)	 600044F	TYPE N PNEUMATIC, ADJUSTABLE 0-10 BAR (FFKM 0-6 BAR)	 600045F	 600047F		
 855543	TYPE N PNEUMATIC 0-10 BAR (FFKM 0-6 BAR)	 855544	TYPE N PNEUMATIC, ADJUSTABLE 0-10 BAR (FFKM 0-6 BAR)	 855545	 855547		

