

Check valve

RE 21534/02.09
Replaces: 10.08

1/8

Type Z1S

Size 6
 Component series 4X
 Maximum operating pressure 350 bar [5076 psi]
 Maximum flow 40 l/min [10.6 US gpm]



H7601

Table of contents

Content	Page
Features	1
Ordering code	2
Symbols	3, 4
Function, sections	4
Technical data	5
Notes	5
Characteristic curves	6
Unit dimensions	7, 8

Features

- Sandwich plate valve for use in vertical stacking assemblies
 - As angled valve
 - As through valve
- Position of ports to ISO 4401-03-02-0-05 and NFPA T3.5.1 R2-2002 D03
- Various checking functions in one or two channels
- Optimum freedom from leakage through poppet made of heavy-duty plastic
- Corrosion-resistant surface on request
- Simple adjustment to special hydraulic fluids by changing the external seal rings
- With measuring points, optional
- As throttle check valve on request
- Supplementary documentation:
 - Sandwich plates NG6, see RE 48050
 - Hydraulic fluids on mineral oil basis see RE 90220

Notes on available spare parts:
www.boschrexroth.com/spc

Ordering code

Z1S	6		-4X/	V /		*
-----	---	--	------	-----	--	---

Check valve, sandwich plate

Size 6

= 6

Through valve

Direction of flow in channel:

A (A2 → A1)	= A
B (B2 → B1)	= B
A (A1 → A2)	= C
B (B1 → B2)	= D
A and B (A1 → A2) and (B1 → B2)	= E
P and T (P2 → P1) and (T1 → T2)	= F
P (P2 → P1)	= P
T (T1 → T2)	= T

Angled valve:

Direction of flow:

B → A	= B-A
T → P	= T-P
AB → P	= AB-P

(For symbols, see page 3)

Cracking pressure

0.5 bar [7.25 psi]	= 05
1.5 bar [21.76 psi]	= 15
3.0 bar [43.51 psi]	= 30
5.0 bar [72.52 psi]	= 50

Further details in clear text

Special version

No code =	Without
SO68 =	Measuring port P (G1/4)
SO90 =	Measuring ports A and B (G1/4)
SO2 =	Measuring port T (G1/4)

Symbols (example), see page 4

No code =	With locating bore ²⁾
62 =	With locating bore and locating pin ISO 8752-3x8-St

Seal material

V =	FKM seals (other seals on request)
-----	------------------------------------

Note!

In the selection, observe the dependency of the operating parameters (fluid, temperature, etc.)!

No code =	Surface not resistant to corrosion ¹⁾
-----------	--

4X =	Component series 40 to 49 (40 to 49: unchanged installation and connection dimensions)
------	--

¹⁾ Corrosion-resistant surface on request.

²⁾ Locating pin ISO 8752-3x8-St, Material no. **R900005694** (separate order)

Symbols: Through valve (① = component side, ② = plate side)

Type Z1S 6 A...

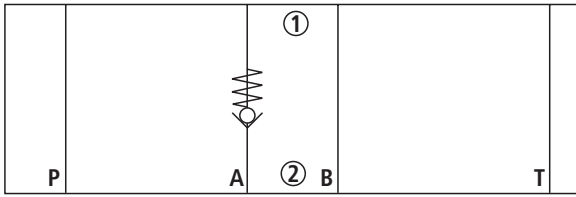

Type Z1S 6 D...

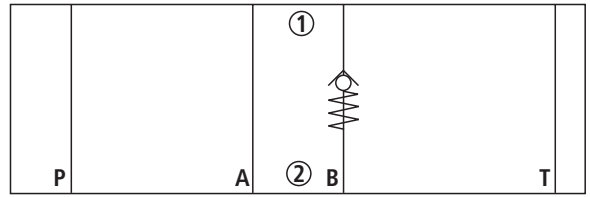

Type Z1S 6 P...

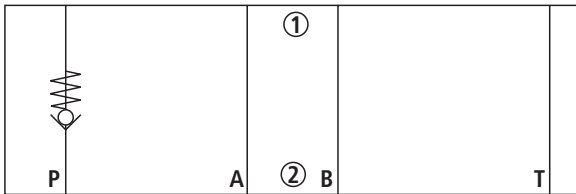

Type Z1S 6 B...

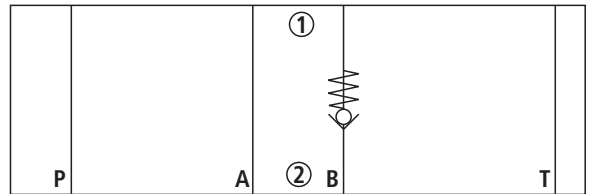

Type Z1S 6 E...

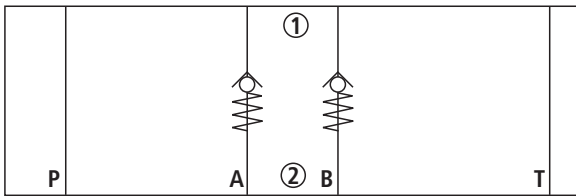

Type Z1S 6 T...

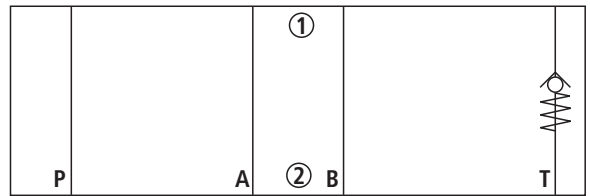

Type Z1S 6 C...

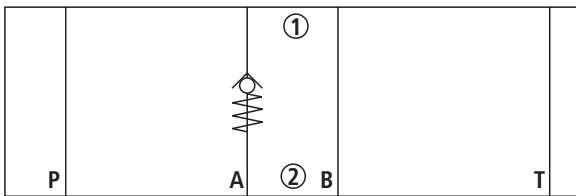

Type Z1S 6 F...

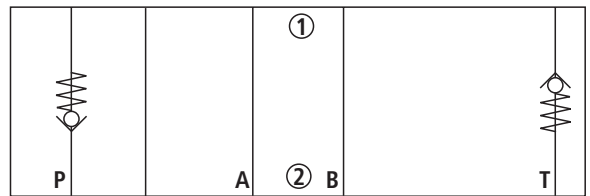

Symbols: Angled valve (① = component side, ② = plate side)

Type Z1S 6 AB-P...

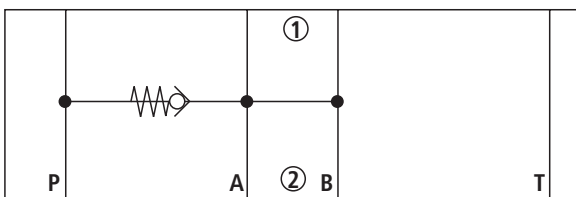

Type Z1S 6 T-P...

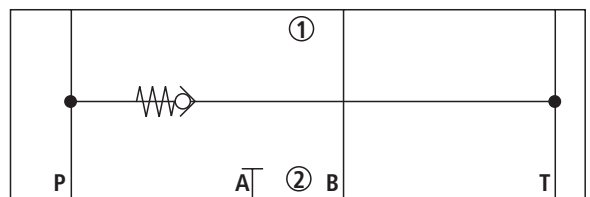

Type Z1S 6 B-A...

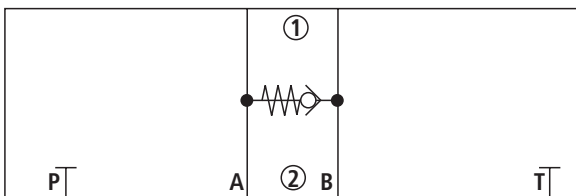

Symbols: Examples of special versions (① = component side, ② = plate side)

Type Z1S 6 P.-4X/...**SO68**
(Check valve in channel P, measuring port P Out G1/4)

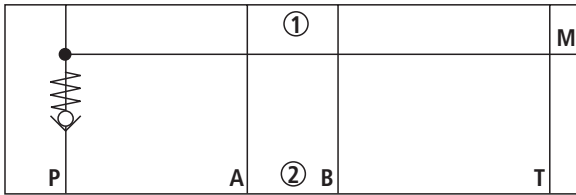

Type Z1S 6 P.-4X/...**SO90**
(Check valve in channel P, measuring ports A and B G1/4)

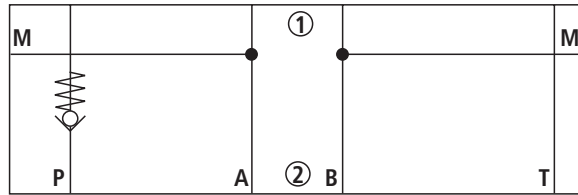

Type Z1S 6 P.-4X/...**SO2**
(Check valve in channel P, measuring port T G1/4)

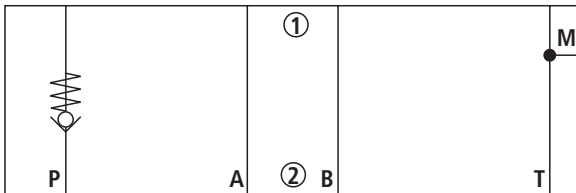

Function, sections

Valves of type Z1S are direct operated check valves of sandwich plate design.

They block the flow leak-free in one direction and allow free flow in the opposite direction.

The stroke of poppet (1) is limited by plastic bushing (2). Integrated spring (3) supports the closing movement. When no fluid flows through the valve, spring (3) holds poppet (1) in the closed position.

In contrast to the through valve (section 1), the angled valve (section 2) checks up to three internal channels. Plug screw (4) serves as positive stop and provides the sealing function.

Attention!

In all installation positions, in which the blue plastic bushing (2) is mounted on the plate side ②, no additional seal ring may be at this place! On the component side ① sealing is achieved (as usual) by means of seal ring (5) of the assembly mounted next.

Integrated plastic bushing (2) assumes a sealing function and must therefore not be removed or damaged!

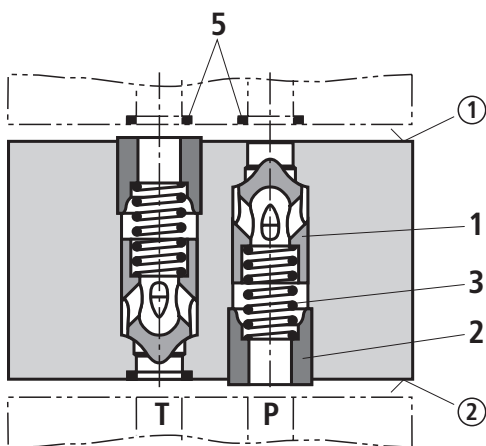

Section 1: Type Z1S 6 F (through valve)

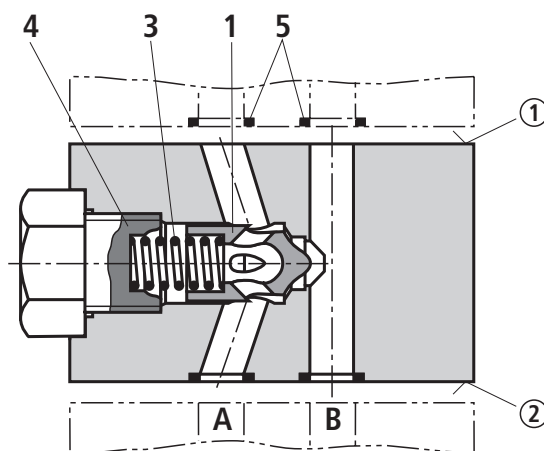

Section 2: Type Z1S 6 BA (angled valve)

Technical data (for applications outside these parameters, please consult us!)**General**

Weight	kg [lbs]	ca. 0.8 [1.76]
Installation position		Optional
Ambient temperature range	°C [°F]	-20 to +80 [-4 to +176]

Hydraulic

Maximum operating pressure	bar [psi]	350 [5076]
Cracking pressure	bar [psi]	0.5; 1.5; 3; 5 [7.25; 21.76; 43.51; 72.52]
Maximum flow	l/min [US gpm]	40 [10.57]
Hydraulic fluid		Mineral oil (HL, HLP) to DIN 51524; other hydraulic fluids on request
Hydraulic fluid temperature range	°C [°F]	-20 to +80 [-4 to +176]
Viscosity range	mm ² /s [SUS]	2.8 to 500 [35 to 2320]
Permissible max. degree of contamination of the hydraulic fluid - cleanliness class to ISO 4406 (c)		Class 20/18/15 ¹⁾

¹⁾ The cleanliness classes specified for components must be adhered to in hydraulic systems. Effective filtration prevents malfunction and, at the same time, prolongs the service life of components.

For the selection of filters, see data sheets RE 50070, RE 50076, RE 50081, RE 50086, RE 50087 and RE 50088.

Notes

- The valve housing (steel) and piston with sealing bushing (plastic bushing) can be disassembled to ensure proper waste disposal.
- The integrated plastic bushing (blue) assumes a sealing function and must therefore not be removed or damaged!
- The check valve inset cannot be ordered separately. In the case of a defect, the valve must therefore be replaced completely.

Characteristic curves: Through valve
(measured with HLP46, $\vartheta_{oil} = 40 \text{ °C} \pm 5 \text{ °C} [104 \text{ °F} \pm 9 \text{ °F}]$)

Δp - q_v characteristic curves (A2 to A1)

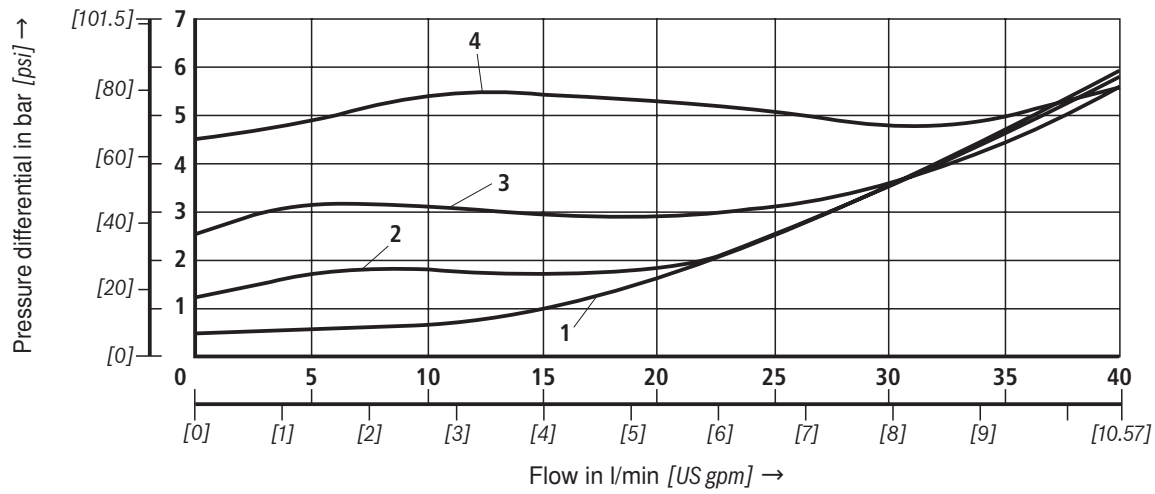

- 1 Cracking pressure 0.5 bar
- 2 Cracking pressure 1.5 bar
- 3 Cracking pressure 3 bar
- 4 Cracking pressure 5 bar

Characteristic curves for angled valve on request.

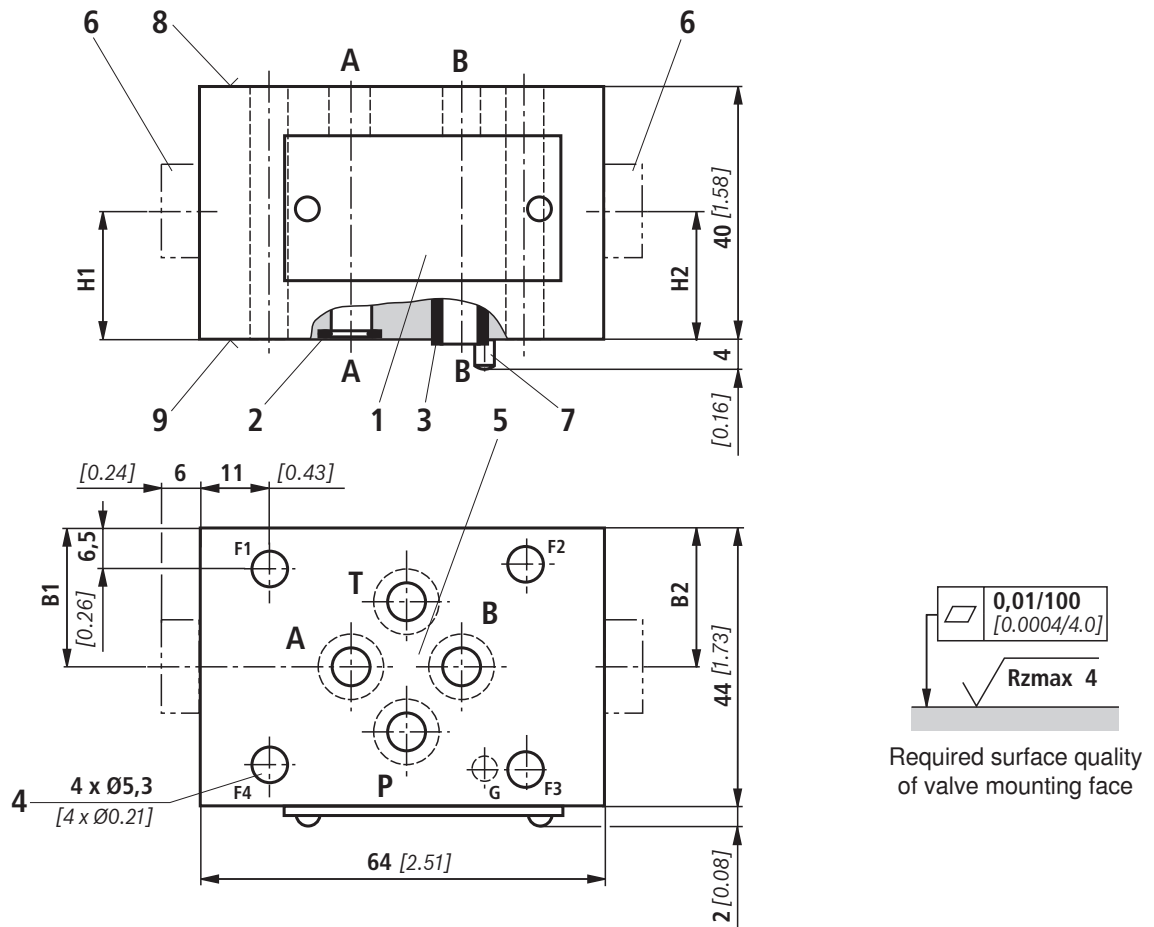
Unit dimensions: Through valve (dimensions in mm [inch])

Type	B1	B2	H1	H2
Z1S 6 C...SO68	22 [0.87]	-	13.5 [0.53]	-
Z1S 6 P...SO68	26.5 [1.04]	-	13 [0.51]	-
Z1S 6 P...SO90	22 [0.87]	22 [0.87]	20 [0.79]	20 [0.79]
Z1S 6 P...SO2	-	17.5 [0.69]	-	20 [0.79]

- 1 Nameplate
- 2 Identical seal rings for ports A, B, P, T (plate side)
- 3 Plastic bushing, blue (plate side)
- 4 Valve mounting bores
- 5 Position of ports to ISO 4401-03-02-0-05 and NFPA T3.5.1 R2-2002 D03
- 6 Plug screw for measuring port, tightening torque $M_T = 30 \text{ Nm}$ [22.1 ft-lbs] +10%
- 7 Locating pin ISO 8752-3x8-St (version "62" only)
- 8 Component side
- 9 Plate side

Valve mounting screws (separate order)
4 hexagon socket head cap screws ISO 4762 - M5 - 10.9
Note!

The length of the valve mounting screws of the sandwich plate valve (length of engagement $\geq 10 \text{ mm}$ [0.39 inch]) must be selected to suit the components mounted above and below the check valve.

The type of screws and the tightening torque must be selected according to the application and individual conditions.

Please consult Rexroth with regard to screws of the required length.

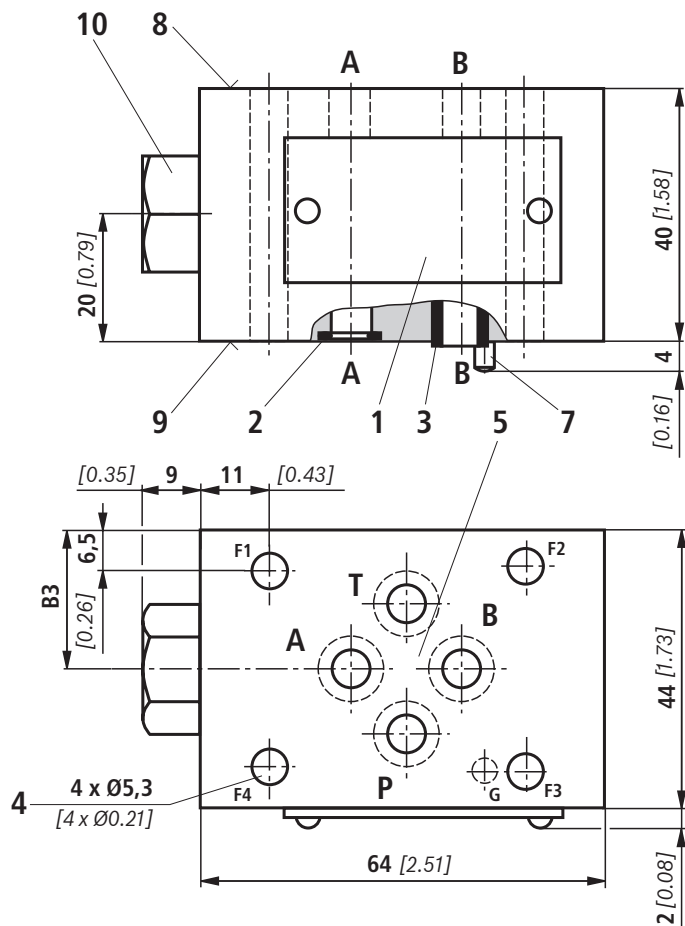
Unit dimensions: Angled valve (dimensions in mm [inch])

Version	B3
"AB-P"	24.5 [0.96]
"T-P"	24.5 [0.96]
"B-A"	22 [0.87]

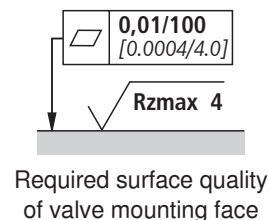

- 1 Nameplate
- 2 Identical seal rings for ports A, B, P, T (plate side)
- 3 Plastic bushing, blue (plate side)
- 4 Valve mounting bores
- 5 Position of ports to ISO 4401-03-02-0-05 and NFPA T3.5.1 R2-2002 D03
- 7 Locating pin ISO 8752-3x8-St (version "62" only)
- 8 Component side
- 9 Plate side
- 10 Plug screw, tightening torque $M_T = 55 \text{ Nm}$ [40.6 ft-lbs] +10%

Valve mounting screws (separate order)

4 hexagon socket head cap screws ISO 4762 - M5 - 10.9

Note!

The length of the valve mounting screws of the sandwich plate valve (length of engagement $\geq 10 \text{ mm}$ [0.39 inch]) must be selected to suit the components mounted above and below the check valve.

The type of screws and the tightening torque must be selected according to the application and individual conditions.

Please consult Rexroth with regard to screws of the required length.